

Client INTEGRATEUR

VERSION 1

Projet: EASYBUS



Bureau: SCHAKO (SUISSE) SA
RUE JEAN PROUVE 28
1762 GIVISIEZ

TEL : 026 460 88 00 FAX: 026 460 88 05

Ce schéma reste la propriété intellectuelle de SCHAKO

Aucune modification ou adaptation n'est autorisée sans notre accord préalable.

Le matériel préconisé doit être installé selon les prescriptions du fabricant.

Les contacts sont représentés respectivement sans tension, froid, sec et à pression nulle.

La section des conducteurs basse tension est à dimensionner selon les prescriptions locales du fournisseur d'énergie.

Type d'installation:

AUTOMAT : SIEMENS POL 638.70 SCHEMA 2 PASSERELLES CONTACTS
AVEC 2 MASTER

REV	NOM	DATE	REV	NOM	DATE
1	GIRARD S.	24.06.2013			
2	LOCHER D.	02.09.2013			
3	LOCHER D.	18.10.2013			
4	LOCHER D.	24.06.2014			

Page suiv. 20.9

				Date	03.11.2014	SCHAKO (SUISSE) SA 1762 Givisiez		PAGE DE GARDE	PASSERELLE CONTACT 2 MASTER	200008_S03a	F 0 de 225 Pg
				Resp.	S.GIRARD						
				Vérif.							
Vers.	Modificat.	Date	Nom	Norme		Origine	Remplace:	Remplacé par:			

INDEX DE

N°	Fichier	Commentaire	Date
1	200008_s03a.0000	PAGE DE GARDE	03.11.2014
2	200008_s03a.0020	AUTOMATE	03.11.2014
3	200008_s03a.0022	PASSERELLE CONTACTS N°1	03.11.2014
4	200008_s03a.0023	PASSERELLE CONTACTS N°2	03.11.2014
5	200008_s03a.0050	ALIMENTATION PRINCIPALE	03.11.2014
6	200008_s03a.0061	ALIMENTATION 24 VAC	03.11.2014
7	200008_s03a.0099	EASYBUS N°1, CCF DESENFUMAGE	03.11.2014
8	200008_s03a.0100	GENERALITES EASYBUS A RESPECTER	03.11.2014
9	200008_s03a.0100a	EASY-M MASTER N°1	03.11.2014
10	200008_s03a.0100b	EXEMPLE DE RACCORDEMENT POUR L'ELECTRICIEN	03.11.2014
11	200008_s03a.0100c	EASY-B	03.11.2014
12	200008_s03a.0100d	EASY-B 230V	03.11.2014
13	200008_s03a.0100e	EASY-R	03.11.2014
14	200008_s03a.0101	ENTREE DIGITALE 1	03.11.2014
15	200008_s03a.0102	ENTREE DIGITALE 2	03.11.2014
16	200008_s03a.0103	ENTREE DIGITALE 3	03.11.2014
17	200008_s03a.0104	ENTREE DIGITALE 4	03.11.2014
18	200008_s03a.0105	ENTREE DIGITALE 5	03.11.2014
19	200008_s03a.0106	ENTREE DIGITALE 6	03.11.2014
20	200008_s03a.0107	ENTREE DIGITALE 7	03.11.2014
21	200008_s03a.0108	ENTREE DIGITALE 8	03.11.2014
22	200008_s03a.0109	ENTREE DIGITALE 9	03.11.2014
23	200008_s03a.0110	ENTREE DIGITALE 10	03.11.2014
24	200008_s03a.0111	ENTREE DIGITALE 11 BOUTON DE QUITTANCE ALARME	03.11.2014
25	200008_s03a.0120	SORTIE DIGITALE 1	03.11.2014
26	200008_s03a.0121	SORTIE DIGITALE 2	03.11.2014
27	200008_s03a.0122	SORTIE DIGITALE 3	03.11.2014
28	200008_s03a.0123	SORTIE DIGITALE 4	03.11.2014
29	200008_s03a.0124	SORTIE DIGITALE 5	03.11.2014
30	200008_s03a.0125	SORTIE DIGITALE 6 PANNE GENERAL A DISTANCE	03.11.2014
31	200008_s03a.0199	EASYBUS N°2, CCF DESENFUMAGE	03.11.2014
32	200008_s03a.0200a	EASY-M MASTER N°2	03.11.2014
33	200008_s03a.0200b	EXEMPLE DE RACCORDEMENT POUR L'ELECTRICIEN	03.11.2014
34	200008_s03a.0200c	EASY-B	03.11.2014
35	200008_s03a.0200d	EASY-B 230V	03.11.2014
36	200008_s03a.0200e	EASY-R	03.11.2014

				Date	03.11.2014	SCHAKO (SUISSE) SA		SOMMAIRE	PASSERELLE CONTACT 2 MASTER	=	
			Resp.	S.GIRARD	+						
			Vérif.								
Vers.	Modificat.	Date	Nom	Norme		Origine	Remplace:	Remplacé par:		200008_s03a	F 1 de 225Pg

A

AUTOMATE

Page suiv. 22.9

F

				Date	03.11.2014	SCHAKO (SUISSE) SA 1762 Givisiez		AUTOMATE	PASSERELLE CONTACT 2 MASTER	=		
				Resp.	S.GIRARD						+	
				Vérif.								
Vers.	Modificat.	Date	Nom	Norme		Origine	Remplace:	Remplacé par:		200008_s03a	F 20 de 225 Pg	

F

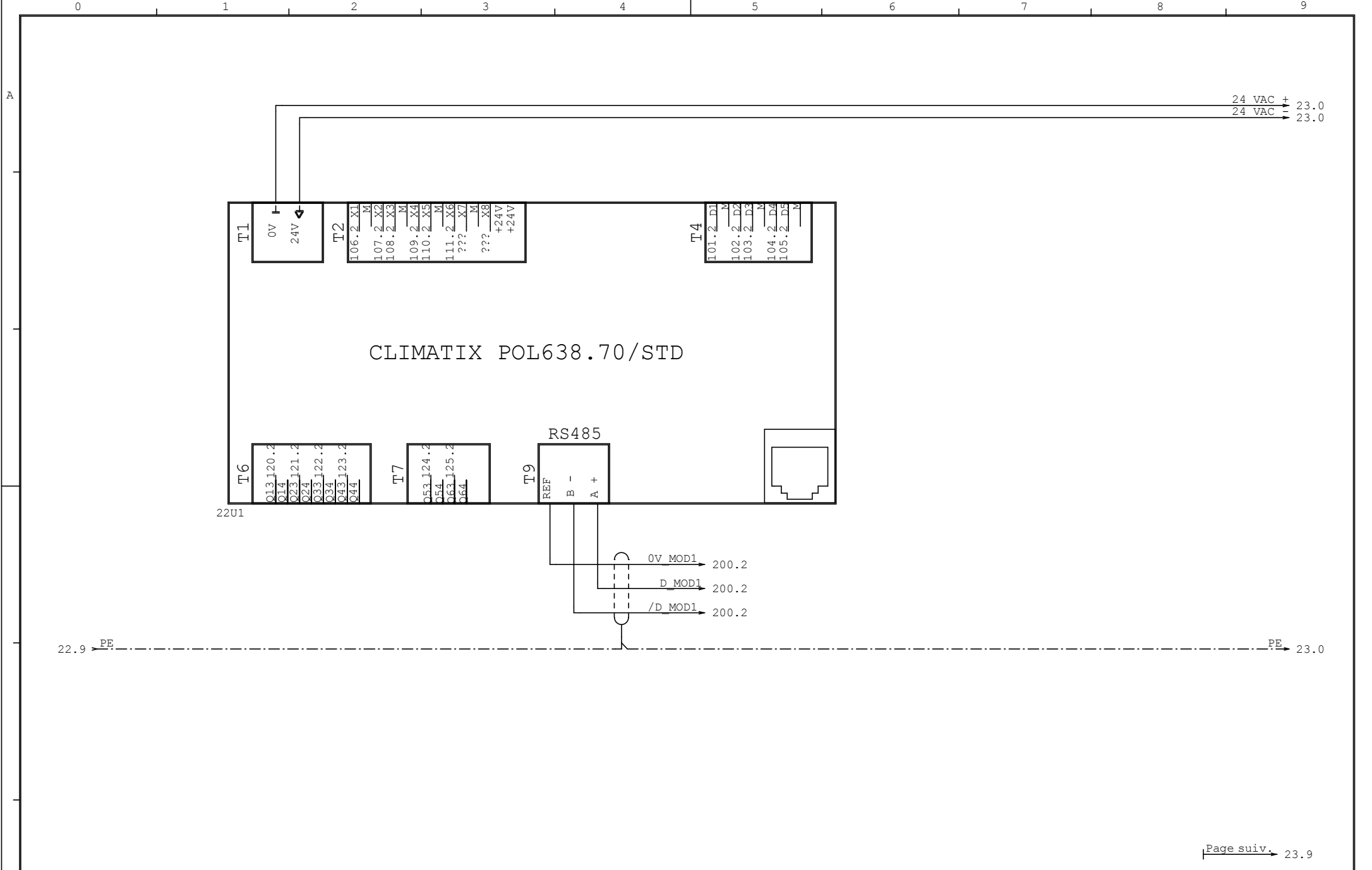

Page suiv. 23.9

				Date	03.11.2014	SCHAKO (SUISSE) SA 1762 Givisiez		PASSERELLE CONTACTS N°1	PASSERELLE CONTACT 2 MASTER	=	F 22
				Resp.	S.GIRARD						
				Vérif.							
Vers.	Modificat.	Date	Nom	Norme		Origine	Remplace:	Remplacé par:		200008_s03a	de 225 Pg

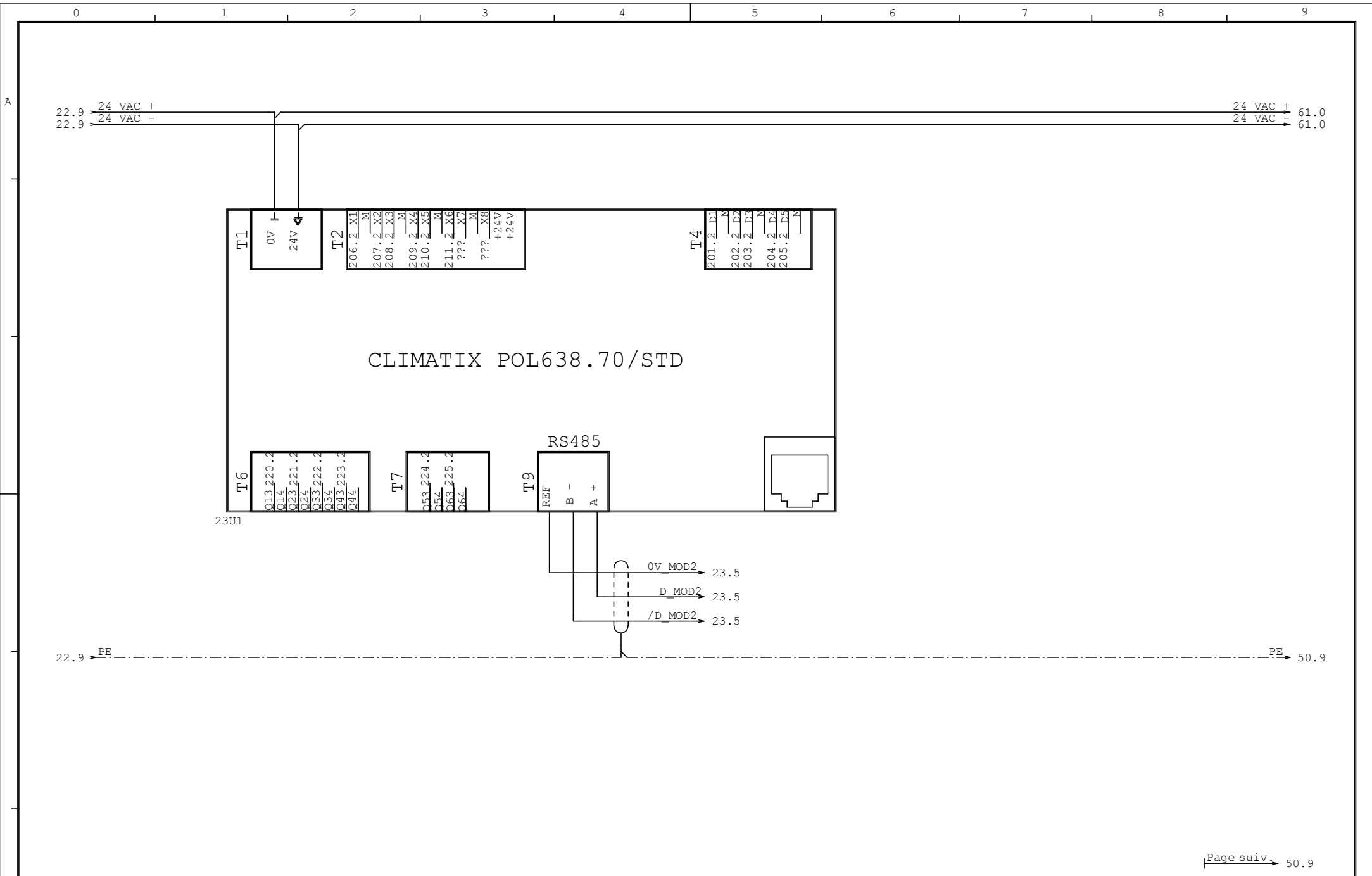

CLIMATIX POL638.70/STD

Page suiv. 50.9

			Date	03.11.2014	SCHAKO (SUISSE) SA			PASSERELLE CONTACTS N°2	PASSERELLE CONTACT 2 MASTER	=		
			Resp.	S.GIRARD	1762 Givisiez							
			Vérif.									
Vers.	Modificat.	Date	Nom	Norme	Origine	Remplace:	Remplacé par:		200008_s03a		F 23 de 225 Pg	

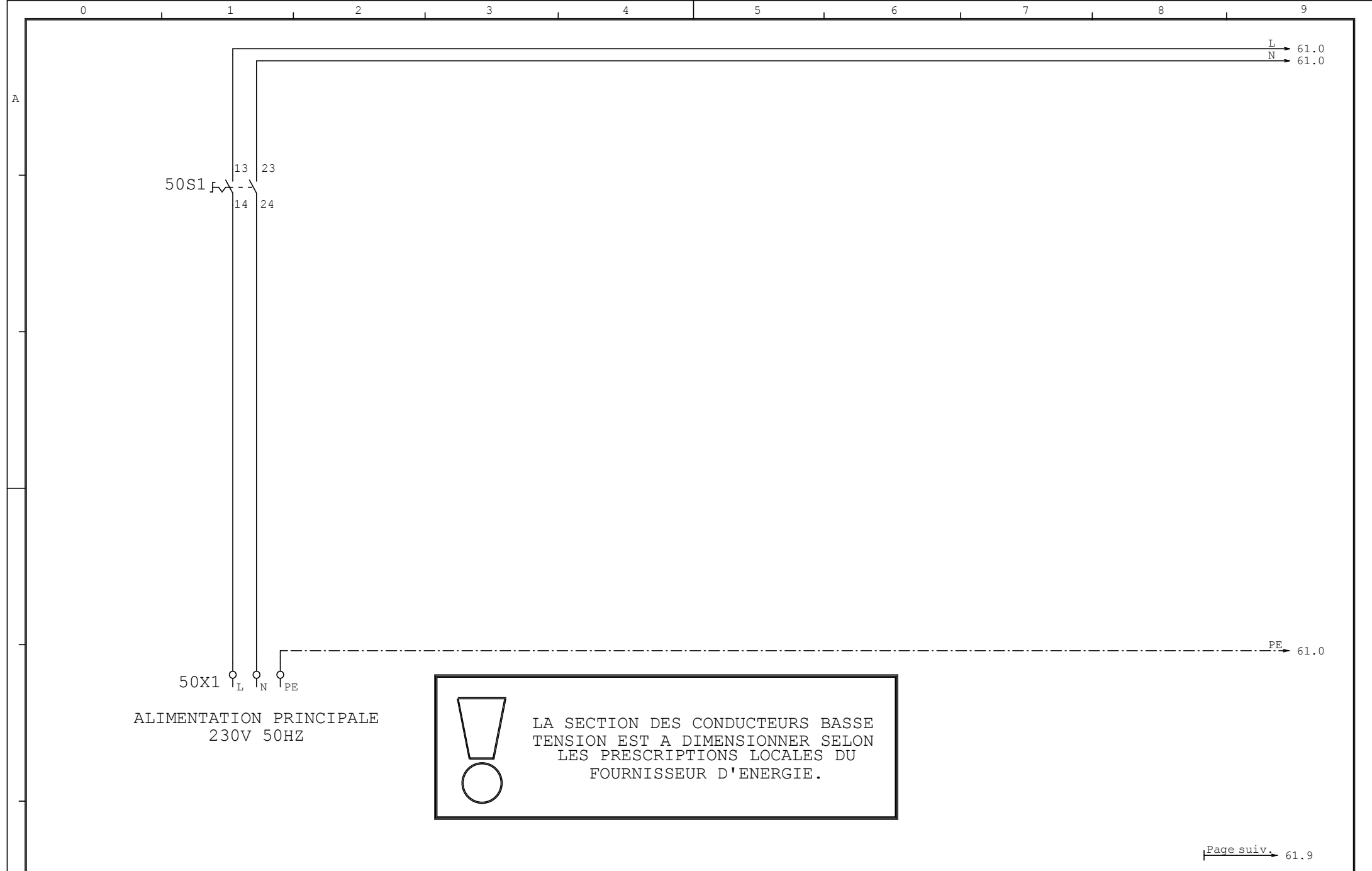

				Date	03.11.2014	SCHAKO (SUISSE) SA		ALIMENTATION PRINCIPALE	PASSERELLE CONTACT 2 MASTER	=	
				Resp.	S.GIRARD	1762 Givisiez				+	
				Vérif.							F 50
Vers.	Modificat.	Date	Nom	Norme	Origine	Remplace:	Remplacé par:		200008_s03a		de 225 Pg

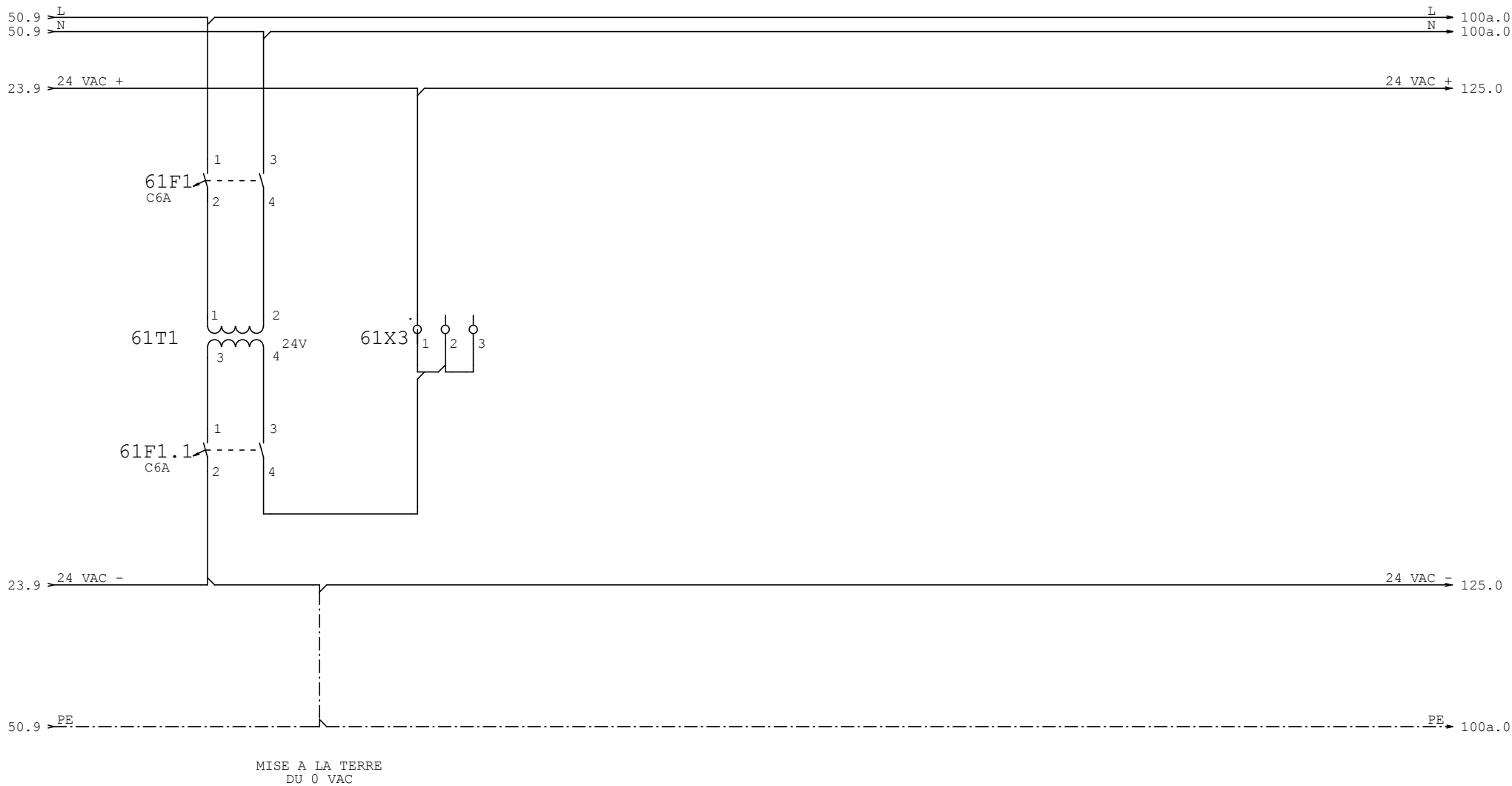

Page suiv. 99.9

				Date	03.11.2014	SCHAKO (SUISSE) SA 1762 Givisiez		ALIMENTATION 24 VAC	PASSERELLE CONTACT 2 MASTER	=	
				Resp.	S.GIRARD					+	
				Vérif.							
Vers.	Modificat.	Date	Nom	Norme		Origine	Remplace:	Remplacé par:		200008_S03a	F 61 de 225 Pg

EASYBUS N°1

CCF

DESENFUMAGE

Page suiv. 100.9

				Date	03.11.2014	SCHAKO (SUISSE) SA 1762 Givisiez		EASYBUS N°1, CCF DESENFUMAGE	PASSERELLE CONTACT 2 MASTER	=	
				Resp.	S.GIRARD					+	
				Vérif.							
Vers.	Modificat.	Date	Nom	Norme		Origine	Remplace:	Remplacé par:		200008_s03a	F 99 de 225 Pg

GENERALITES EASYBUS A RESPECTER

- La longueur total du bus est de 1000M
- Le nombre maximum de participants est de 128
- La topologie est indifférente
- Si plusieurs Master, les cannaux doivent être différents pour chaque réseau EasyBus
- Le filtre est à placer à une distance de > 50 cm de tout variateur de fréquence
- Raccordez le câble du Bus directement sur le filtre sans passer par des bornes minimum 3x2.5mm²

- Ce schéma reste la propriété intellectuelle de SCHAKO
- Aucune modification ou adaptation n'est autorisée sans notre accord préalable.
- Le matériel préconisé doit être installé selon les prescriptions du fabricant.
- Les contacts sont représentés respectivement sans tension, froid, sec et à pression nulle.
- La section des conducteurs basse tension est à dimensionner selon les prescriptions locales du fournisseur d'énergie.
- Le dimensionnement des lignes électrique est l'affaire du concepteur respectivement de l'installateur électricien. Section minimum du câble 3x2.5mm²

Page suiv. 100a.9

				Date	03.11.2014	SCHAKO (SUISSE) SA		GENERALITES EASYBUS A RESPECTER	PASSERELLE CONTACT 2 MASTER	=		
				Resp.	S.GIRARD						+	
				Vérif.		1762 Givisiez						
Vers.	Modificat.	Date	Nom	Norme		Origine	Remplace:	Remplacé par:			de 225Pg	

61.9 L → 200.0
 61.9 N → 200.0
 61.9 PE → 101.0

VERS AUTOMATE
 RS-485 / 232
 MODBUS RTU
 BAUDRATE=19200
 BITS=8-E-2
 ADRESSE=1

0V MOD1
 D MOD1
 /D MOD1

RACCORDEMENT
 DU BLINDAGE
 A LA TERRE
 UNIQUEMENT
 D'UN COTE
 DU CABLE

CABLE TD 3X2.5MM2
 FIL PE A RACCORDER
 UNIQUEMENT DU COTE
 DU FILTRE

SCHAKO
 EASY-F
 200mmX150mm

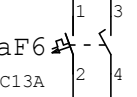

LE FILTRE EST A PLACER A UNE
 DISTANCE > 50 CM DE TOUT VARIATEUR
 DE FREQUENCE

FILTRE

100aU6

SCHAKO
 EASY-M
 160mmX90mm

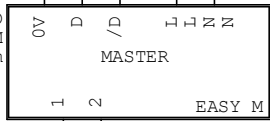

CONTACT FEU

RACCORDER LE CABLE DIRECTEMENT SUR LE
 FILTRE SANS PASSER PAR DES BORNES
 MINIMUM 3X2.5MM2

CABLE A DIMENSIONNER
 SELON LA PUISSANCE
 UTILISEE

! SI PLUSIEURS MASTER,
 LES CANAUX DOIVENT ETRE
 DIFFERENTS POUR CHAQUE
 RESEAU EASYBUS

EXEMPLE ICI : FREQ = 1 CANAL = 1

INTERNE AU TABLEAU
 EXTERNE AU TABLEAU

RENOVI EN PAGE 100b
 EXEMPLE DE RACCORDMENT
 POUR L'ELECTRICIEN

Page suiv. 100b.9

Date	03.11.2014	SCHAKO (SUISSE) SA	EASY-M MASTER N°1	PASSERELLE CONTACT 2 MASTER	F 100a				
Resp.	S.GIRARD								
Vérif.									
Vers.	Modificat.	Date	Nom	Norme	Origine	Remplace:	Remplacé par:	200008_s03a	F de 225Pg

INTERNE AU TABLEAU
 EXTERNE AU TABLEAU

RENOVI EN P. 100a VERS FILTRE

**EXEMPLE DE RACCORDMENT
 POUR L'ELECTRICIEN**

CABLE A DIMENSIONNER
 SELON LA PUISSANCE
 UTILISEE

BOITE DE
 DERIVATION

CABLE PLAT WOERTZ LNPE

CABLE PLAT WOERTZ LNPE

BOITIER DE RACCORDEMENT
 WOERTZ

BOITIER DE RACCORDEMENT
 WOERTZ

VERS 1ERE LIGNE
 DU BUS N°1

VERS 2EME LIGNE
 DU BUS N°1

Page suiv. 100c.9

Date		03.11.2014		SCHAKO (SUISSE) SA		EXEMPLE DE RACCORDEMENT POUR L'ELECTRICIEN		PASSERELLE CONTACT 2 MASTER		=	
Resp.		S.GIRARD		1762 Givisiez		KLIMA-LUFT		200008_s03a		F 100b	
Vérif.				Origine		Remplace:		Remplacé par:		de 225 Pg	
Vers.	Modificat.	Date	Nom	Norme							

A

INTERNE AU TABLEAU
 EXTERNE AU TABLEAU

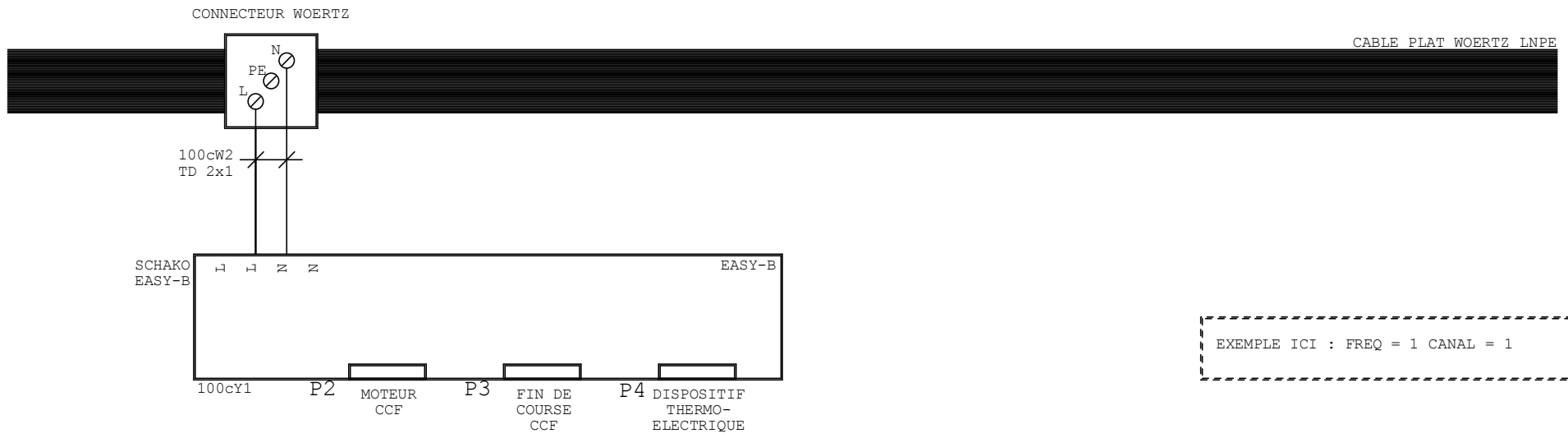

EXEMPLE ICI : FREQ = 1 CANAL = 1

ADRESSE :

Page suiv. 100d.9

F

				Date	03.11.2014	SCHAKO (SUISSE) SA 1762 Givisiez		EASY-B	PASSERELLE CONTACT 2 MASTER	=	F 100c						
				Resp.	S.GIRARD							Origine	Remplace:	Remplacé par:	200008_s03a	+	de 225Pg
				Vérif.													
Vers.	Modificat.	Date	Nom	Norme													

F

A

INTERNE AU TABLEAU
 EXTERNE AU TABLEAU

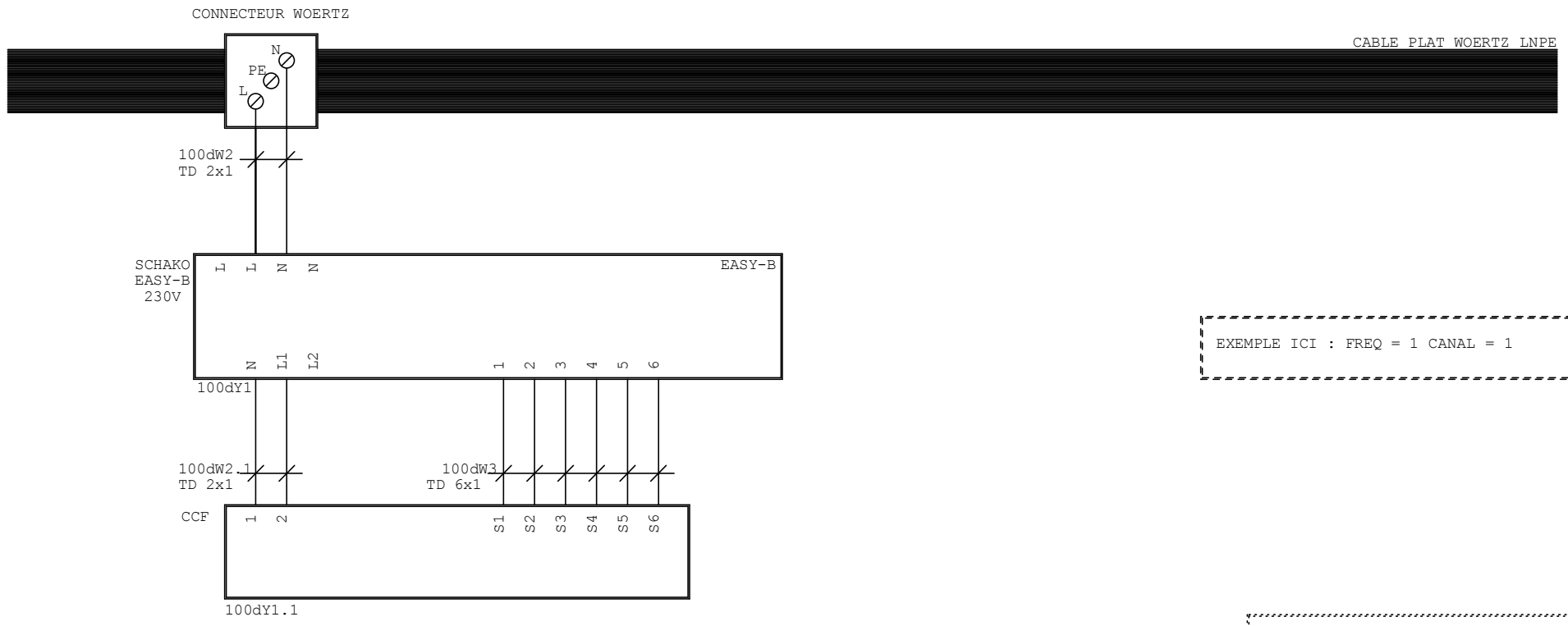

EXEMPLE ICI : FREQ = 1 CANAL = 1

ADRESSE :

Page suiv. 100e.9

F

				Date	03.11.2014	SCHAKO (SUISSE) SA 1762 Givisiez		EASY-B 230V	PASSERELLE CONTACT 2 MASTER	=	F 100d			
				Resp.	S.GIRARD							200008_s03a	+	de 225Pg
				Vérif.										
Vers.	Modificat.	Date	Nom	Norme		Origine	Remplace:	Remplacé par:						

F

A

INTERNE AU TABLEAU
 EXTERNE AU TABLEAU

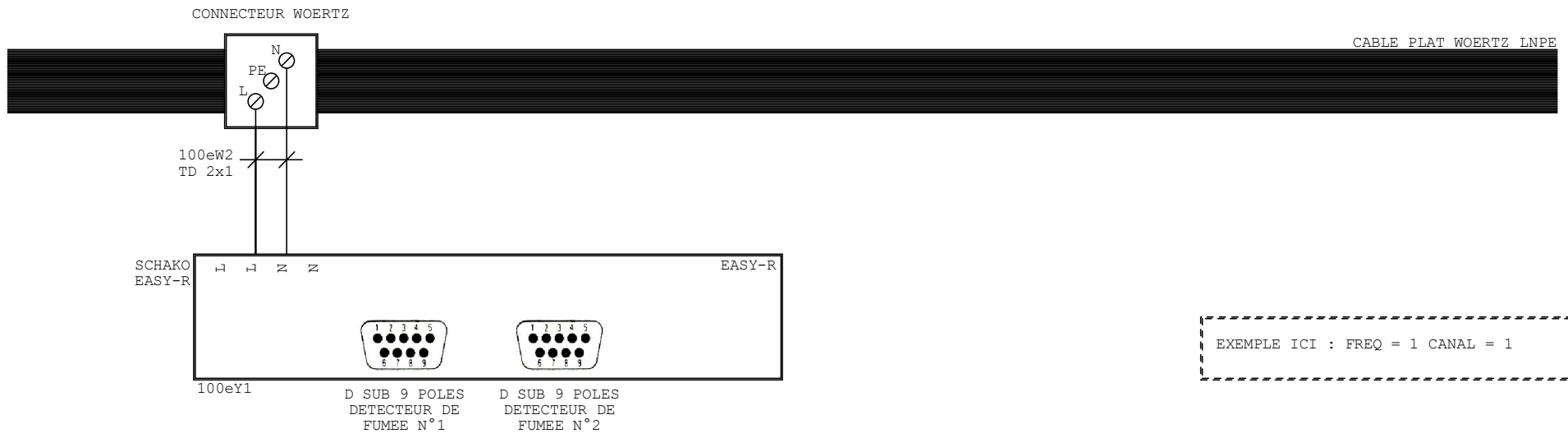

EXEMPLE ICI : FREQ = 1 CANAL = 1

ADRESSE :

Page suiv. 101.9

F

			Date	03.11.2014	SCHAKO (SUISSE) SA		EASY-R	PASSERELLE CONTACT 2 MASTER	=		
			Resp.	S.GIRARD						+	
			Vérif.						1762 Givisiez		
Vers.	Modificat.	Date	Nom	Norme	Origine	Remplace:	Remplacé par:		200008_s03a	F 100e de 225 Pg	

F

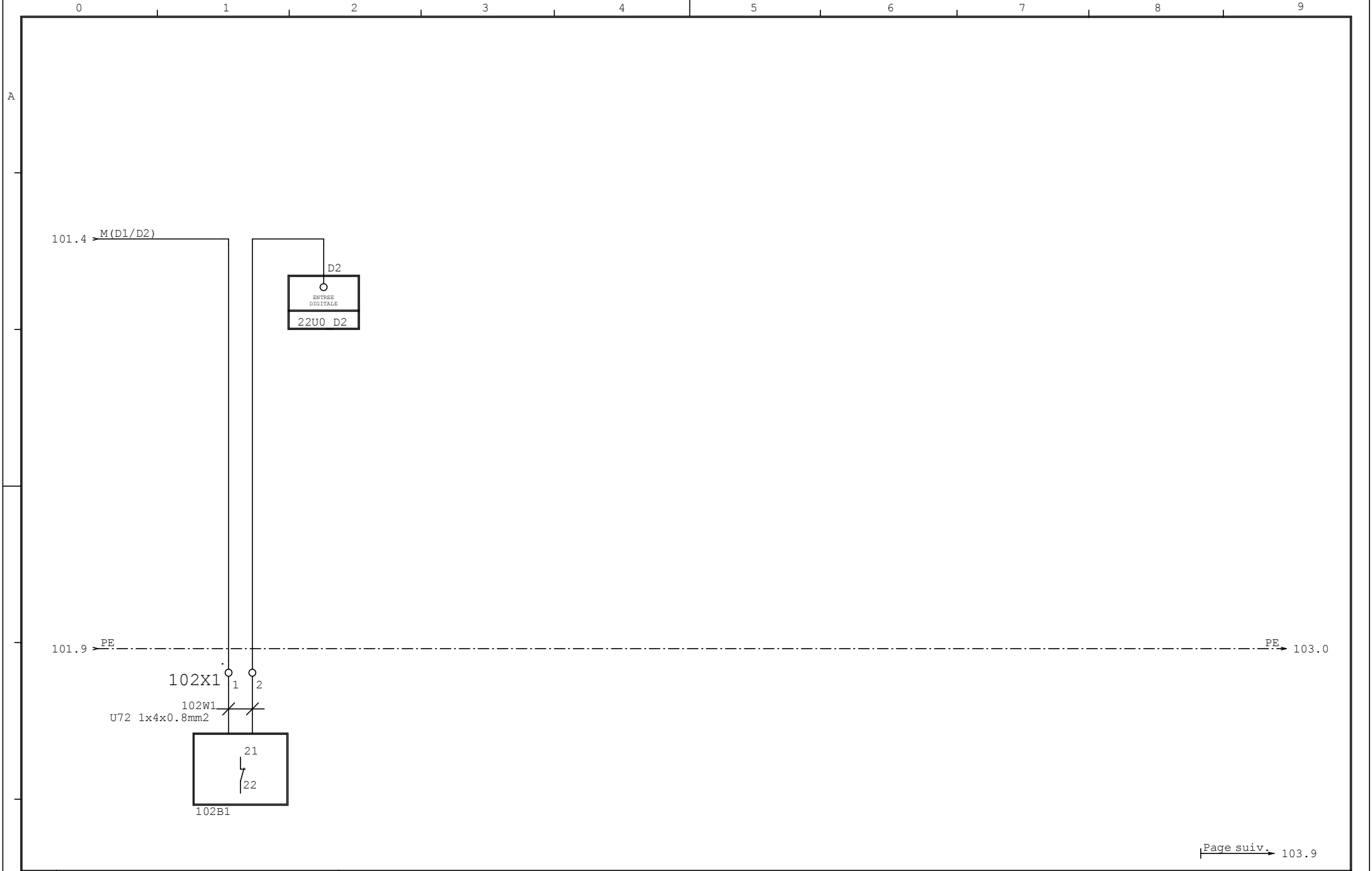

Page suiv. 103.9

			Date	03.11.2014	SCHAKO (SUISSE) SA		ENTREE DIGITALE 2	PASSERELLE CONTACT 2 MASTER	=				
			Resp.	S.GIRARD									
			Vérif.						1762 Givisiez				
Vers.	Modificat.	Date	Nom	Norme	Origine	Remplace:	Remplacé par:		200008_s03a	F 102 de 225 Pg			

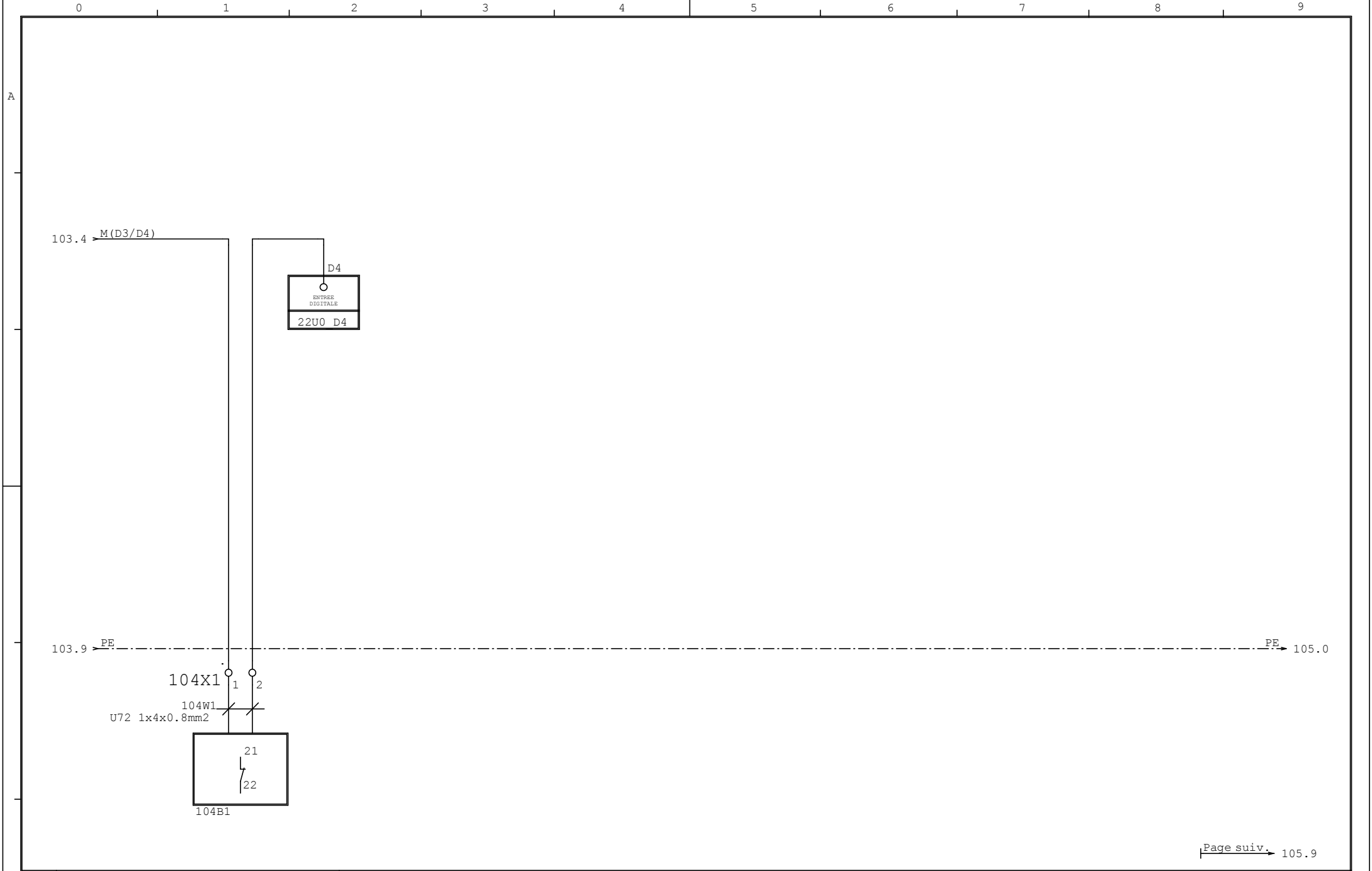

Page suiv. 105.9

			Date	03.11.2014	SCHAKO (SUISSE) SA		ENTREE DIGITALE 4	PASSERELLE CONTACT 2 MASTER	=				
		Resp.	S.GIRARD										
		Vérif.		1762 Givisiez									
Vers.	Modificat.	Date	Nom	Norme	Origine	Remplace:	Remplacé par:	200008_s03a	F	104			
0			1		2	3	4	5	6	7	8	9	F

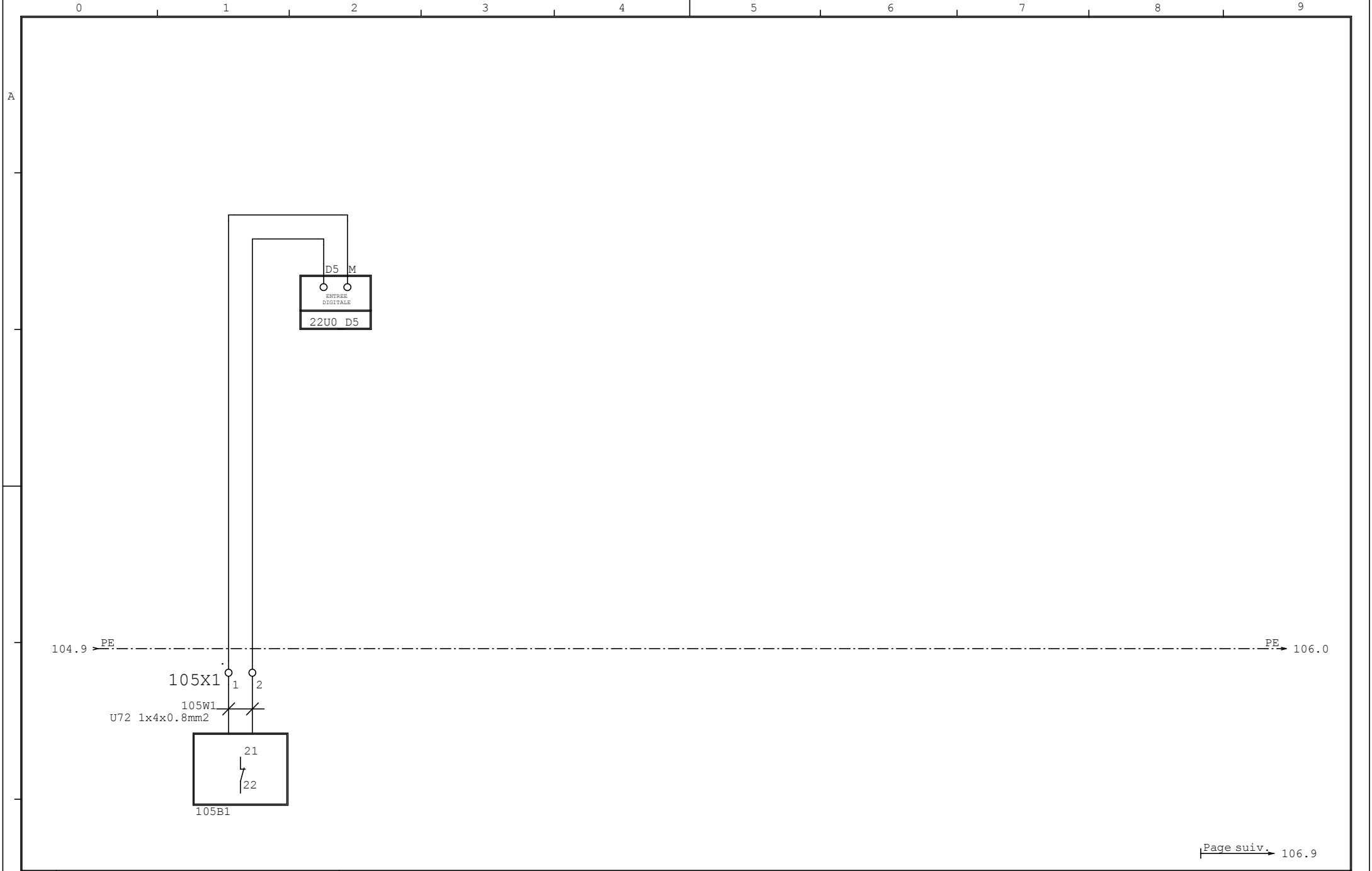

Page suiv. 106.9

			Date	03.11.2014	SCHAKO (SUISSE) SA 1762 Givisiez		ENTREE DIGITALE 5	PASSERELLE CONTACT 2 MASTER	=	
		Resp.	S.GIRARD	+						
		Vérif.								
Vers.	Modificat.	Date	Nom	Norme	Origine	Remplace:	Remplacé par:		200008_s03a	F 105 de 225 Pg

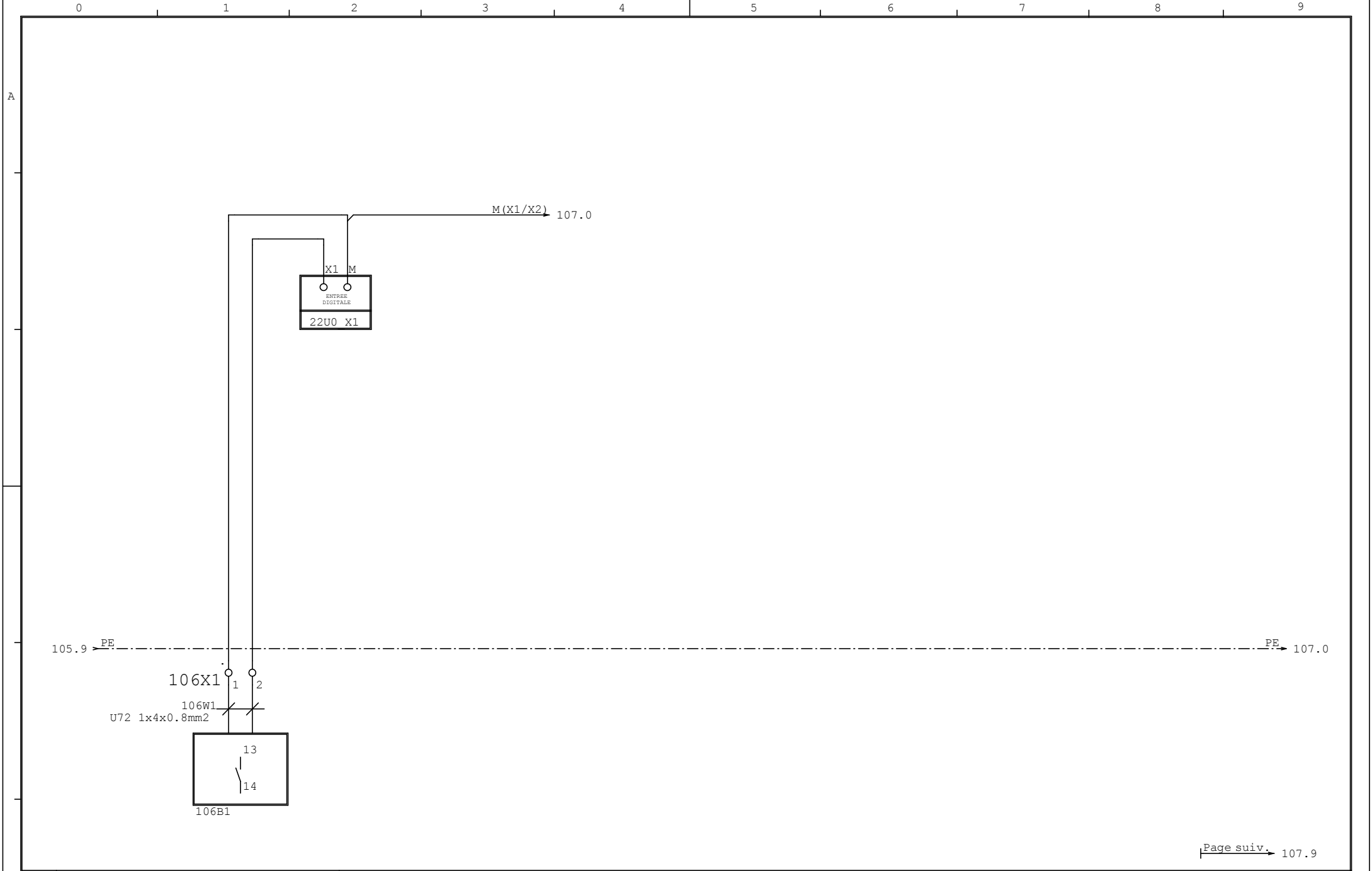

Page suiv. 107.9

			Date	03.11.2014	SCHAKO (SUISSE) SA		ENTREE DIGITALE 6	PASSERELLE CONTACT 2 MASTER	=			
			Resp.	S.GIRARD								
			Vérif.						1762 Givisiez			
Vers.	Modificat.	Date	Nom	Norme	Origine	Remplace:	Remplacé par:	200008_s03a		de 225 Pg		

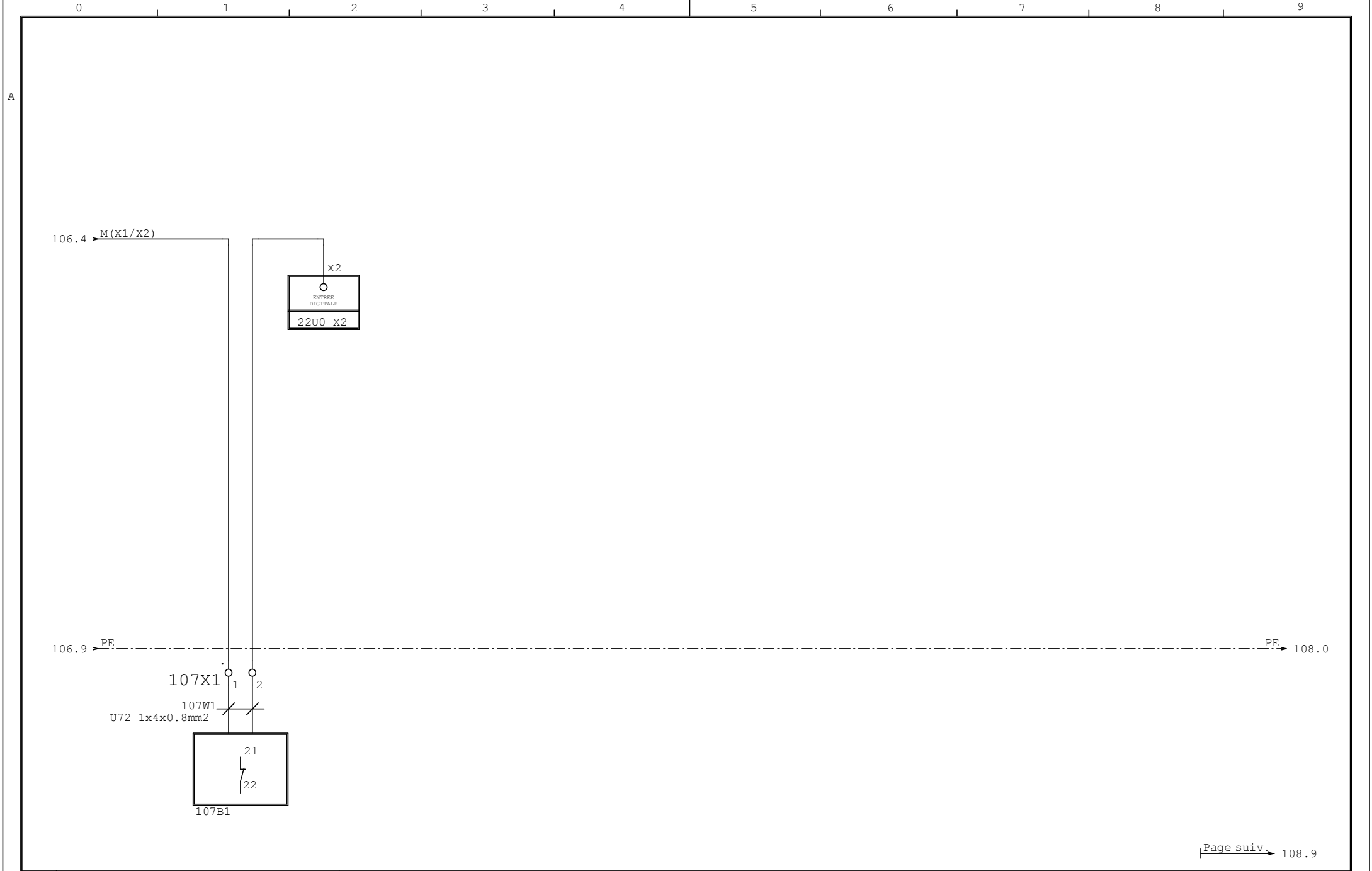

Page suiv. 108.9

				Date	03.11.2014	SCHAKO (SUISSE) SA		ENTREE DIGITALE 7	PASSERELLE CONTACT 2 MASTER	=				
				Resp.	S.GIRARD									
				Vérif.						1762 Givisiez				
Vers.	Modificat.	Date	Nom	Norme		Origine	Remplace:	Remplacé par:		200008_s03a	F 107 de 225 Pg			

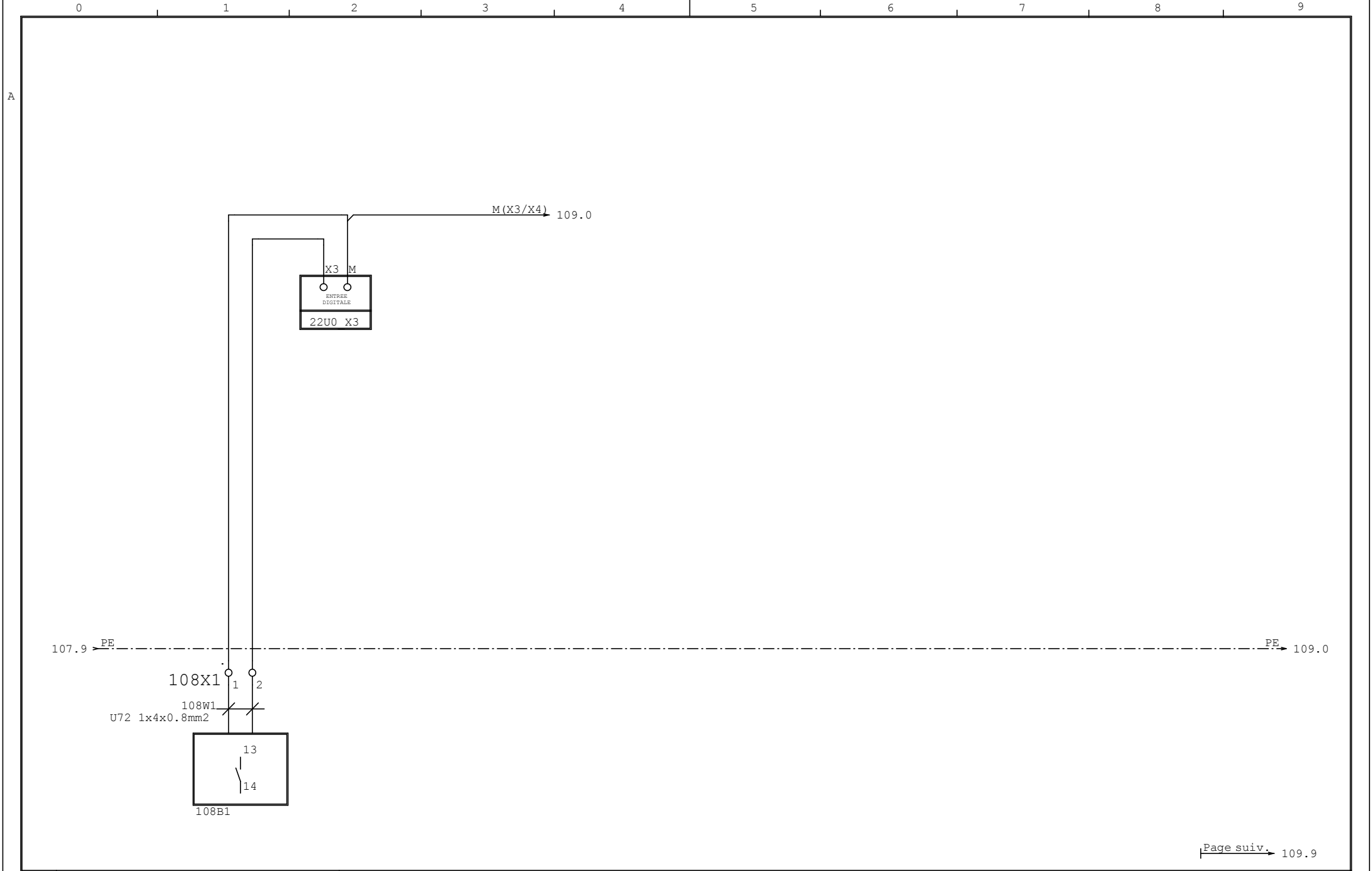

Page suiv. 109.9

				Date	03.11.2014	SCHAKO (SUISSE) SA 1762 Givisiez		ENTREE DIGITALE 8	PASSERELLE CONTACT 2 MASTER	=			
				Resp.	S.GIRARD								
				Vérif.									
Vers.	Modificat.	Date	Nom	Norme		Origine	Remplace:	Remplacé par:		200008_s03a	F 108 de 225 Pg		

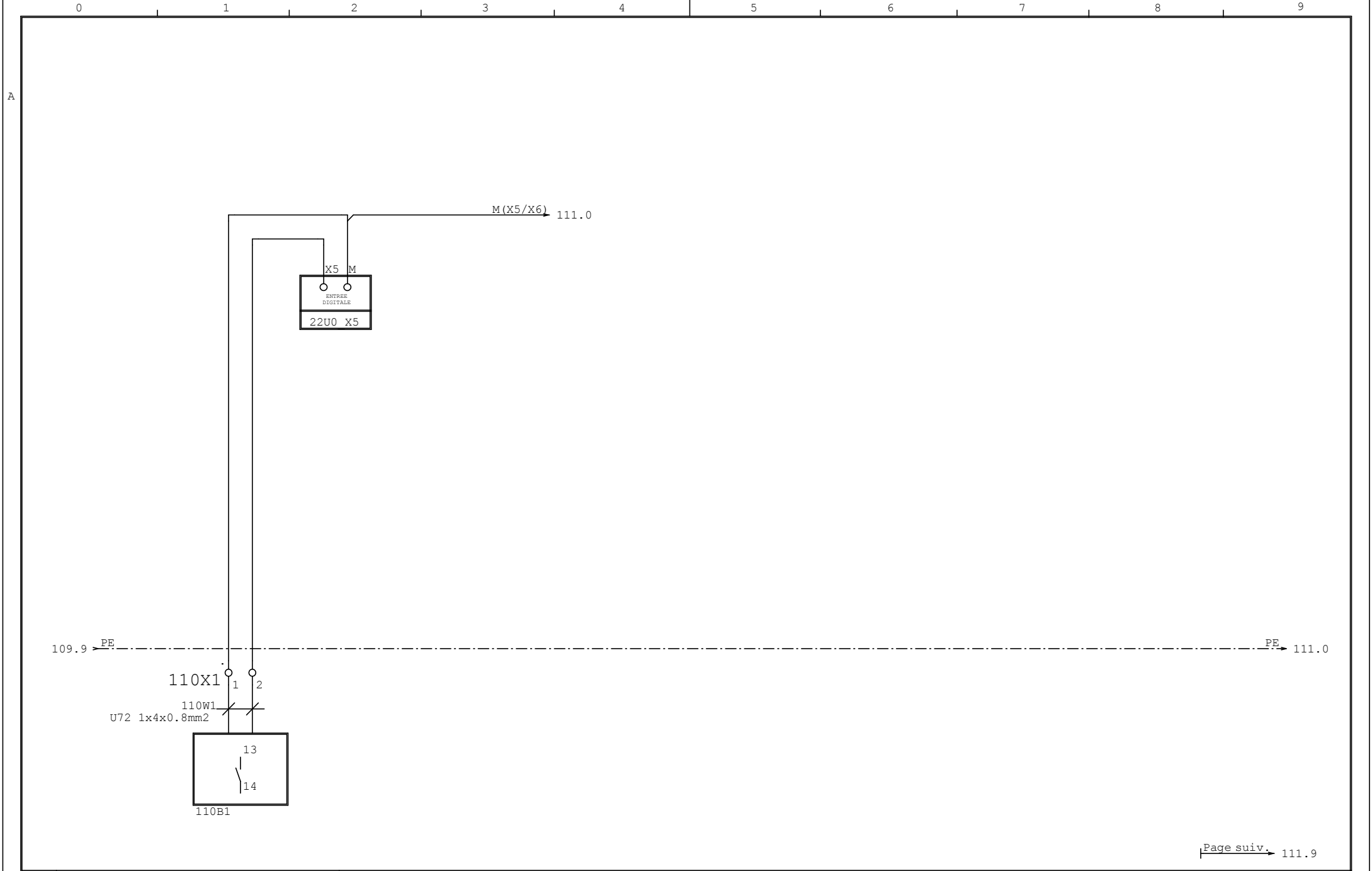

Page suiv. 111.9

				Date	03.11.2014	SCHAKO (SUISSE) SA 1762 Givisiez		ENTREE DIGITALE 10	PASSERELLE CONTACT 2 MASTER	=				
				Resp.	S.GIRARD									
				Vérif.										
Vers.	Modificat.	Date	Nom	Norme		Origine	Remplace:	Remplacé par:		200008_s03a	F 110 de 225 Pg			

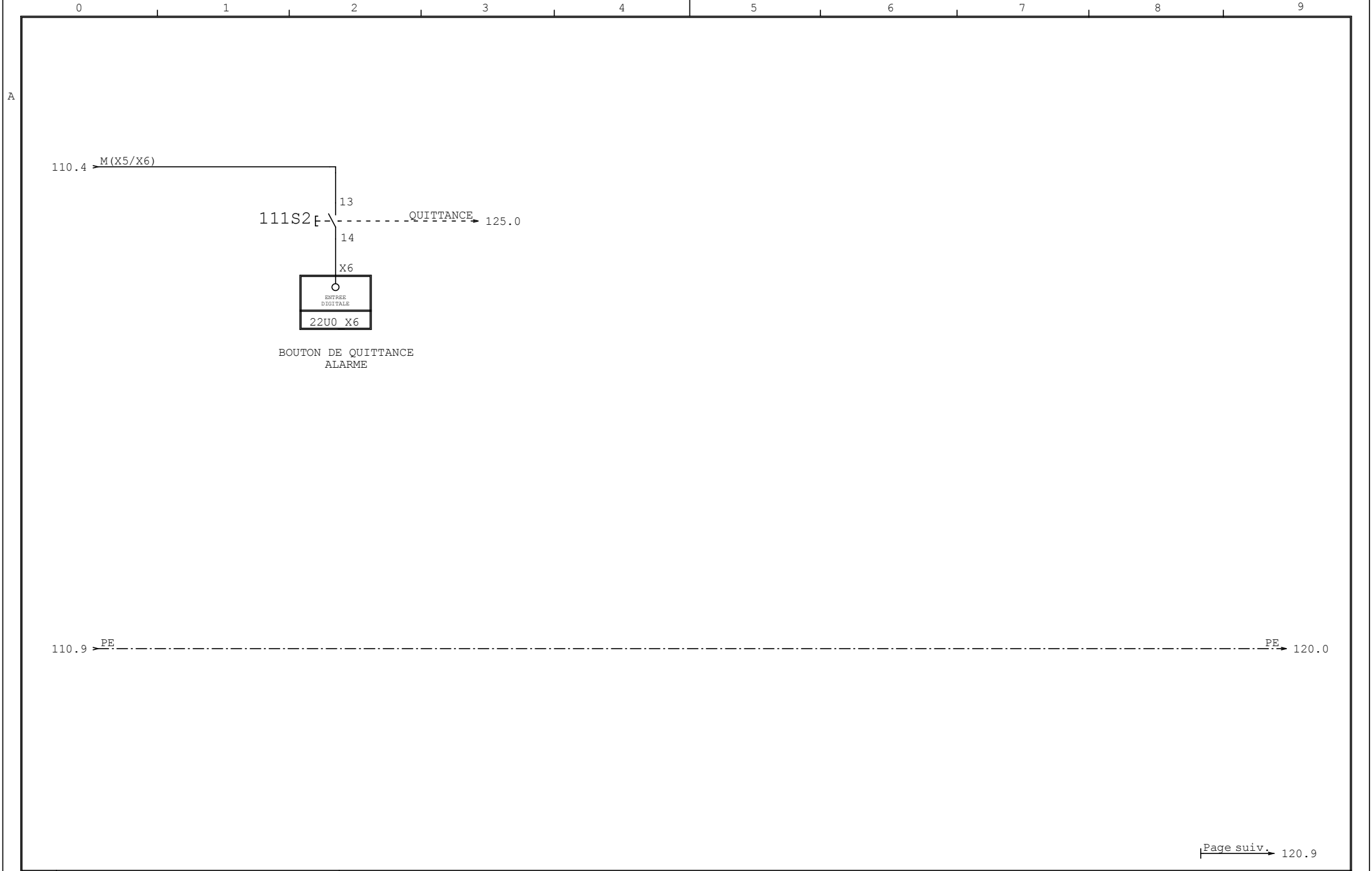

Page suiv. 120.9

				Date	03.11.2014	SCHAKO (SUISSE) SA			ENTREE DIGITALE 11	PASSERELLE CONTACT 2 MASTER	=		
				Resp.	S.GIRARD	1762 Givisiez			BOUTON DE			+	
				Vérif.					QUITTANCE ALARME				F 111
Vers.	Modificat.	Date	Nom	Norme		Origine	Remplace:	Remplacé par:		200008_s03a		de 225 Pg	

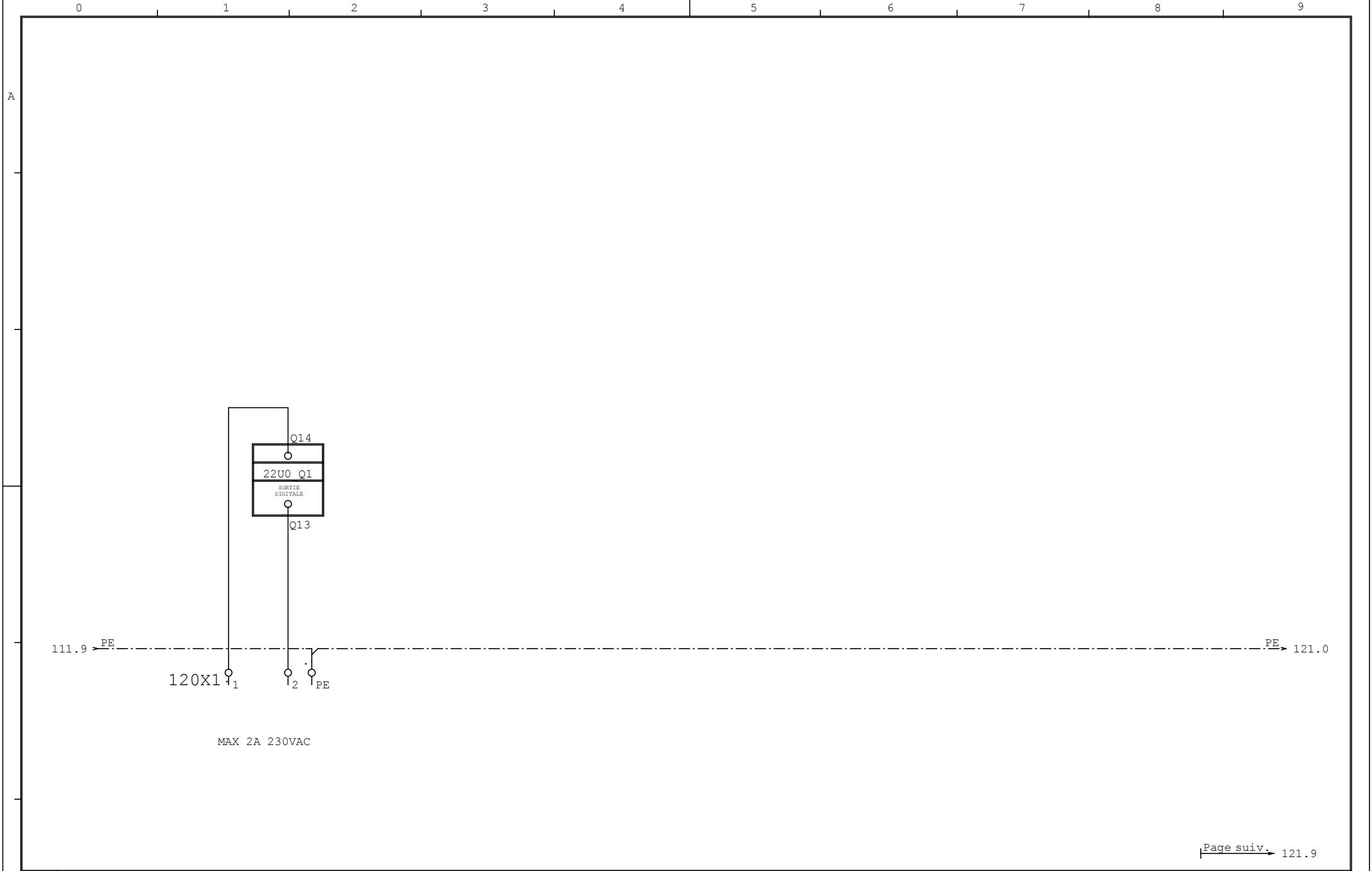

Page suiv. 121.9

			Date	03.11.2014	SCHAKO (SUISSE) SA			SORTIE DIGITALE 1		PASSERELLE CONTACT 2 MASTER	=	
			Resp.	S.GIRARD	1762 Givisiez						+	
			Vérif.									F 120
Vers.	Modificat.	Date	Nom	Norme	Origine	Remplace:	Remplacé par:			200008_s03a		de 225 Pg

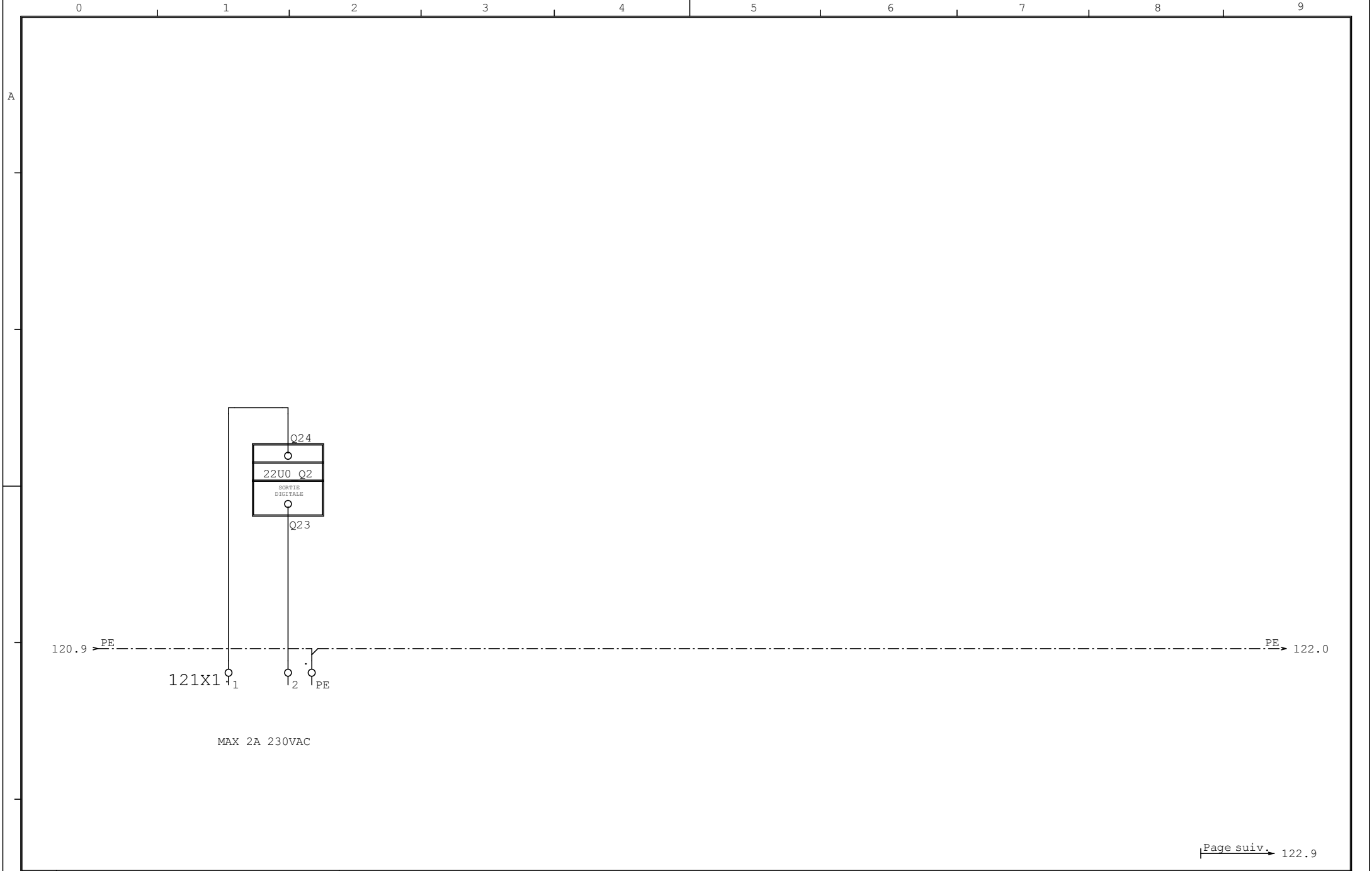

Page suiv. 122.9

			Date	03.11.2014	SCHAKO (SUISSE) SA			SORTIE DIGITALE 2		PASSERELLE CONTACT 2 MASTER	=	
			Resp.	S.GIRARD	1762 Givisiez						+	
			Vérif.									F 121
Vers.	Modificat.	Date	Nom	Norme	Origine	Remplace:	Remplacé par:			200008_s03a	de 225 Pg	

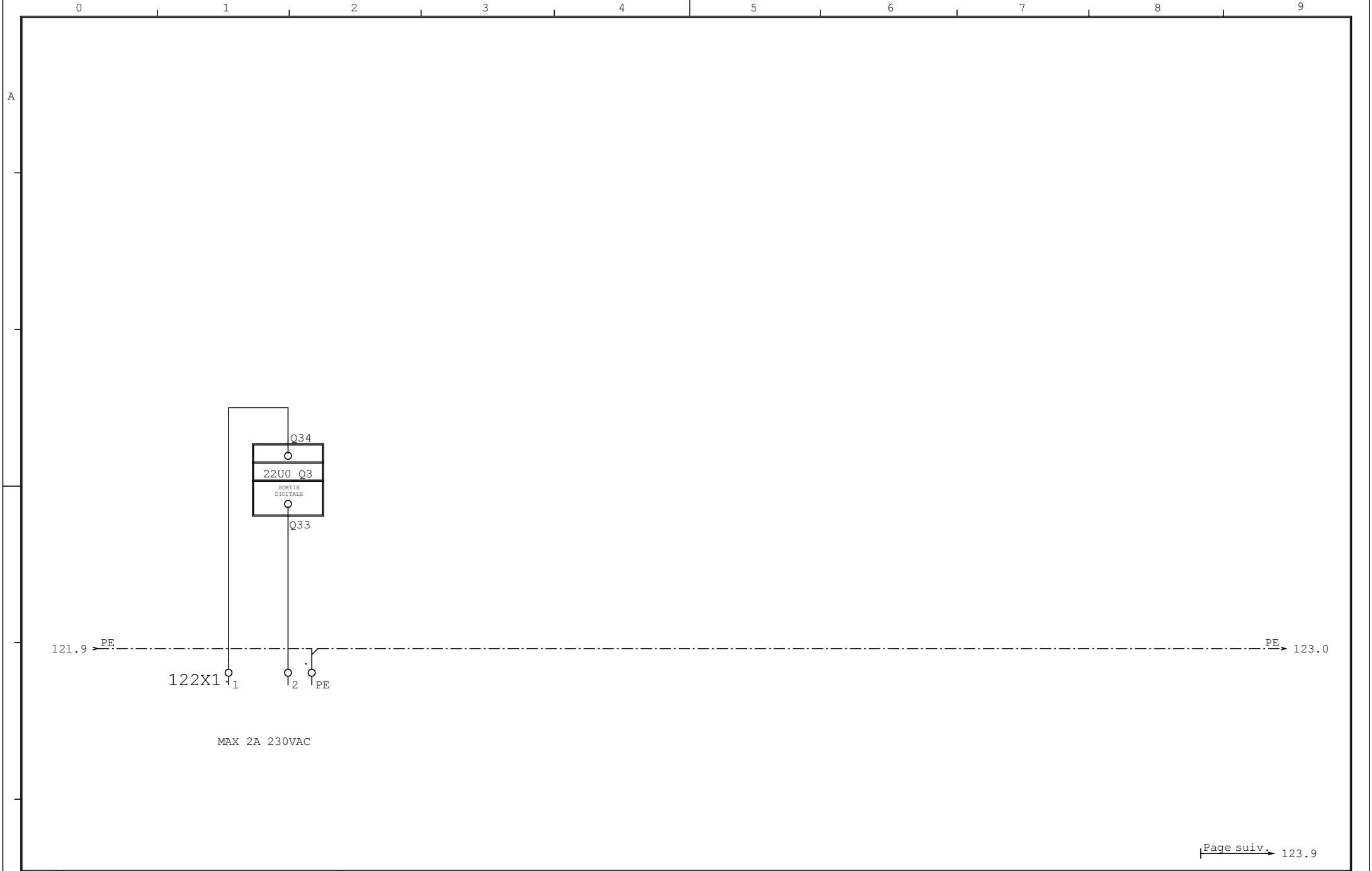

Page suiv. 123.9

				Date	03.11.2014	SCHAKO (SUISSE) SA		SORTIE DIGITALE 3	PASSERELLE CONTACT 2 MASTER	=				
				Resp.	S.GIRARD									
				Vérif.						1762 Givisiez				
Vers.	Modificat.	Date	Nom	Norme		Origine	Remplace:	Remplacé par:		200008_s03a	F 122 de 225 Pg			

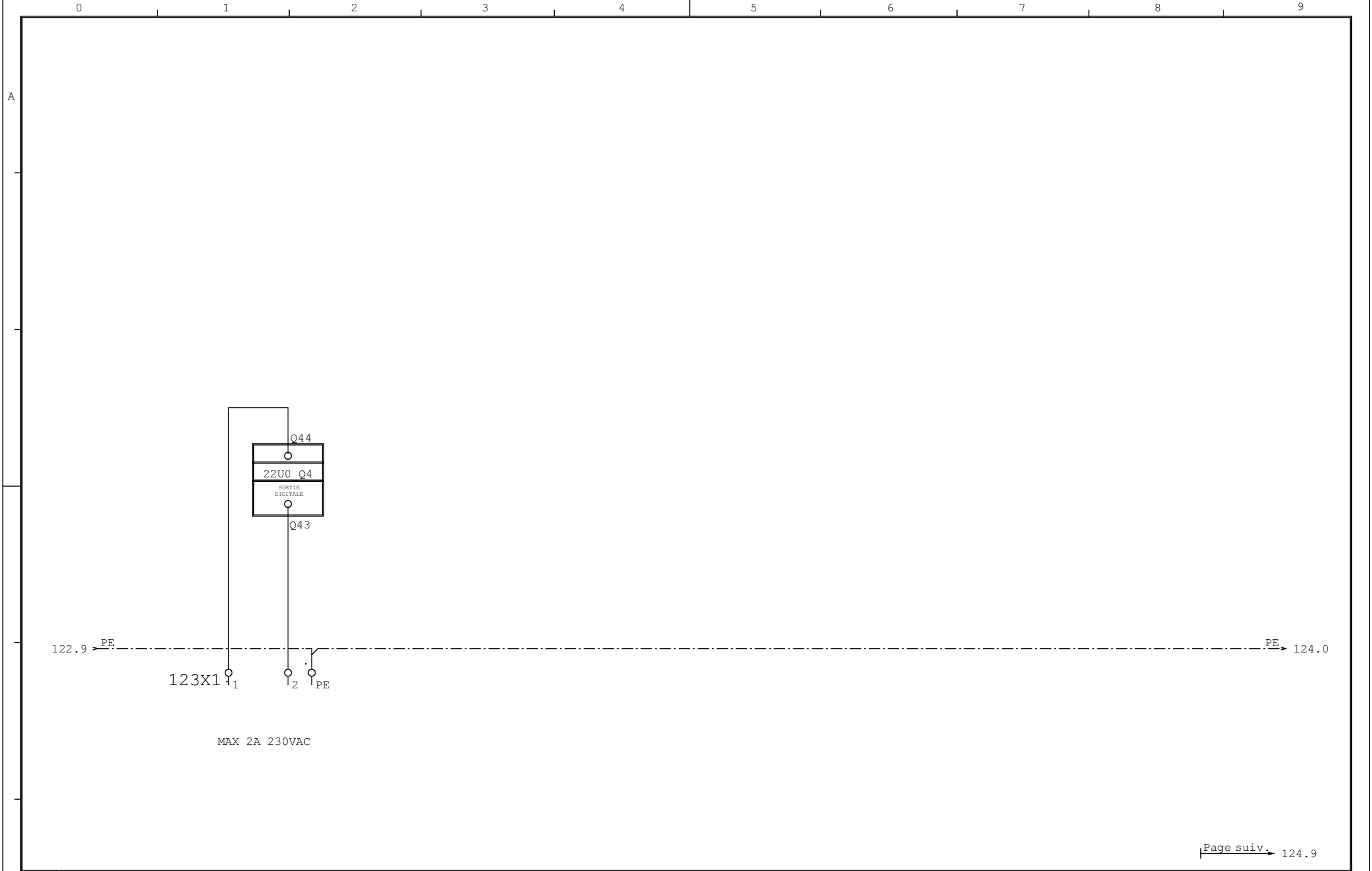

Page suiv. 124.9

			Date	03.11.2014	SCHAKO (SUISSE) SA			SORTIE DIGITALE 4		PASSERELLE CONTACT 2 MASTER	=	
			Resp.	S.GIRARD	1762 Givisiez						+	
			Vérif.									F 123
Vers.	Modificat.	Date	Nom	Norme	Origine	Remplace:	Remplacé par:			200008_s03a		de 225 Pg

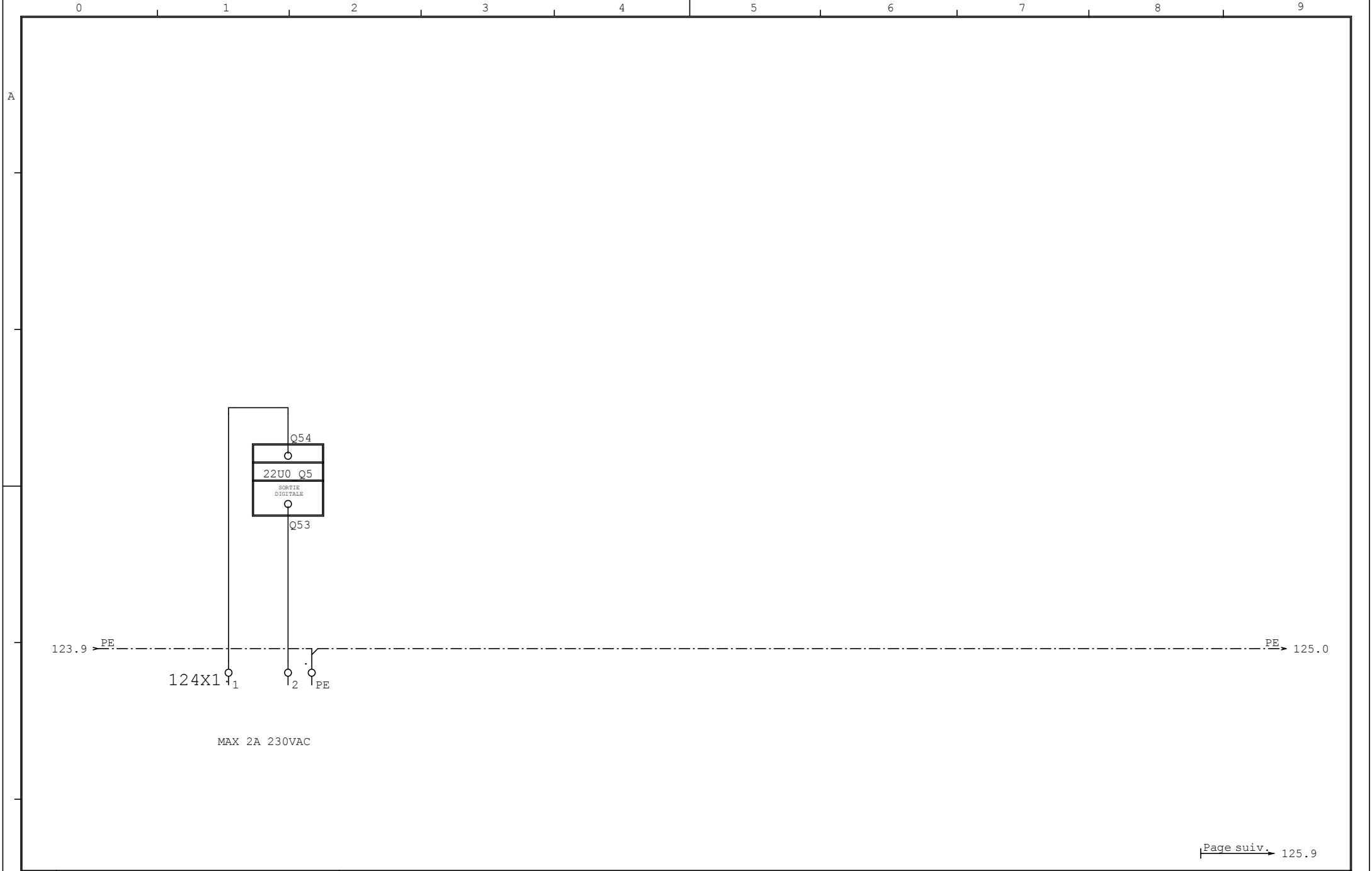

Page suiv. 125.9

				Date	03.11.2014	SCHAKO (SUISSE) SA		SORTIE DIGITALE 5	PASSERELLE CONTACT 2 MASTER	=			
				Resp.	S.GIRARD								
				Vérif.						1762 Givisiez			
Vers.	Modificat.	Date	Nom	Norme		Origine	Remplace:	Remplacé par:		200008_s03a	F 124 de 225 Pg		

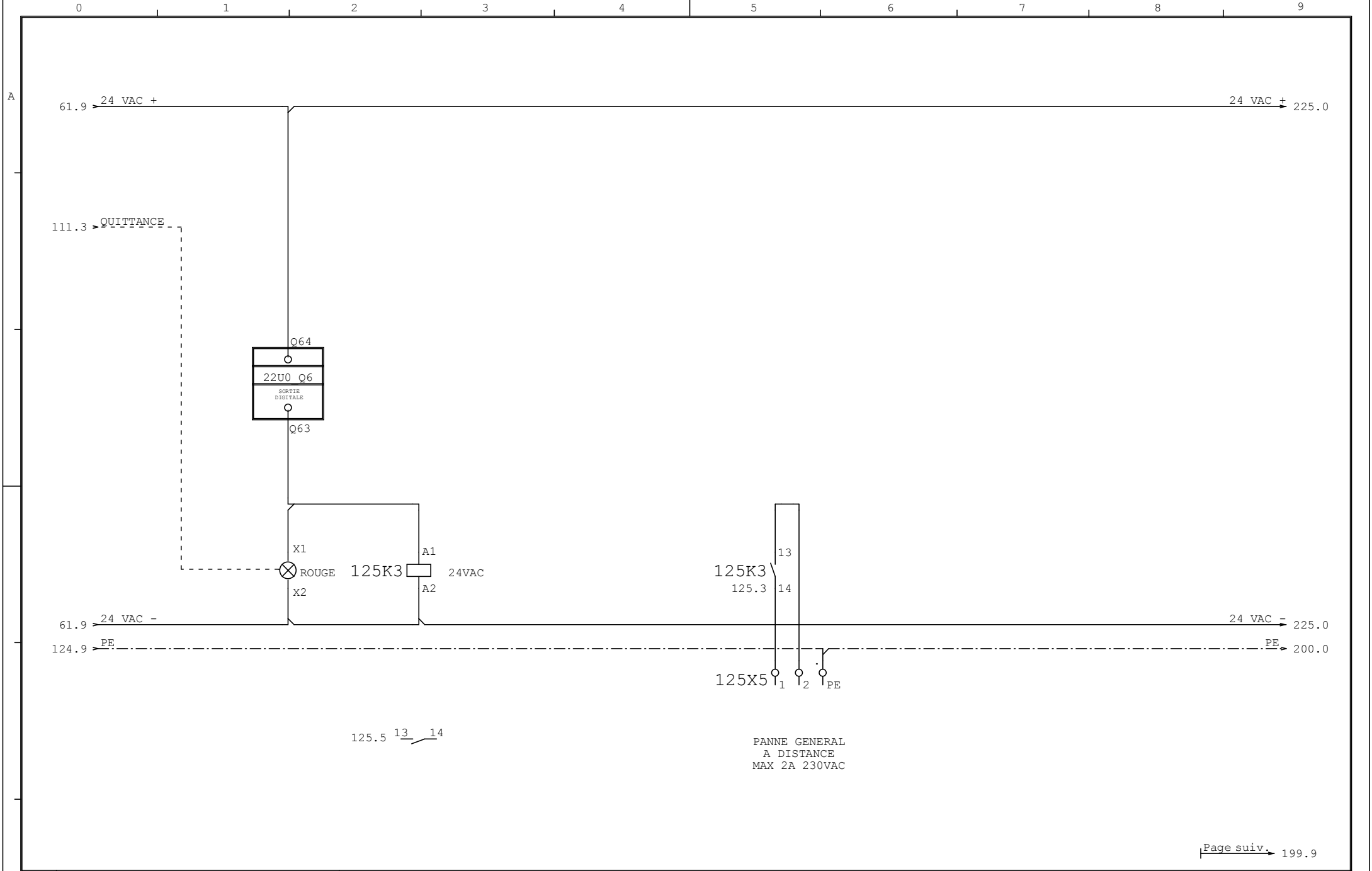

Page suiv. 199.9

				Date	03.11.2014	SCHAKO (SUISSE) SA			SORTIE DIGITALE 6		PASSERELLE CONTACT 2 MASTER		=
				Resp.	S.GIRARD	1762 Givisiez			PANNE GENERAL				+
				Vérif.					A DISTANCE				F 125
Vers.	Modificat.	Date	Nom	Norme		Origine	Remplace:	Remplacé par:			200008_s03a		de 225 Pg

EASYBUS N°2

CCF

DESENFUMAGE

Page suiv. 200.9

				Date	03.11.2014	SCHAKO (SUISSE) SA 1762 Givisiez		EASYBUS N°2, CCF DESENFUMAGE	PASSERELLE CONTACT 2 MASTER	=	
				Resp.	S.GIRARD					+	
				Vérif.							
Vers.	Modificat.	Date	Nom	Norme		Origine	Remplace:	Remplacé par:		200008_s03a	F 199 de 225 Pg

200.9 L
 200.9 N
 200.9 PE

L → 200a.0
 N → 200a.0
 PE → 201.0

VERS AUTOMATE
 RS-485 / 232
 MODBUS RTU
 BAUDRATE=19200
 BITS=8-E-2
 ADRESSE=1

0V MOD1
 D MOD1
 /D MOD1

RACCORDEMENT
 DU BLINDAGE
 A LA TERRE
 UNIQUEMENT
 D'UN COTE
 DU CABLE

CABLE TD 3X2.5MM2
 FIL PE A RACORDER
 UNIQUEMENT DU COTE
 DU FILTRE

200aF6
 C13A

SCHAKO
 EASY-F
 200mmX150mm

LE FILTRE EST A PLACER A UNE
 DISTANCE > 50 CM DE TOUT VARIATEUR
 DE FREQUENCE

FILTRE

200aU6

SCHAKO
 EASY-M
 160mmX90mm

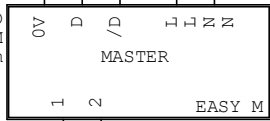

RACCORDER LE CABLE DIRECTEMENT SUR LE
 FILTRE SANS PASSER PAR DES BORNES
 MINIMUM 3X2.5MM2

CABLE A DIMENSIONNER
 SELON LA PUISSANCE
 UTILISEE

! SI PLUSIEURS MASTER,
 LES CANAUX DOIVENT ETRE
 DIFFERENTS POUR CHAQUE
 RESEAU EASYBUS

EXEMPLE ICI : FREQ = 1 CANAL = 2

INTERNE AU TABLEAU
 EXTERNE AU TABLEAU

RENOVI EN PAGE 200b
 EXEMPLE DE RACCORDMENT
 POUR L'ELECTRICIEN

Page suiv. 200b.9

Date	03.11.2014	SCHAKO (SUISSE) SA		EASY-M MASTER N°2	PASSERELLE CONTACT 2 MASTER	=
Resp.	S.GIRARD					
Vérif.						
Vers.		1762 Givisiez				F 200a
Modificat.		Origine	Remplace:	Remplacé par:	200008_s03a	de 225Pg

INTERNE AU TABLEAU
 EXTERNE AU TABLEAU

RENOVI EN P. 200a VERS FILTRE

**EXEMPLE DE RACCORDMENT
 POUR L'ELECTRICIEN**

CABLE A DIMENSIONNER
 SELON LA PUISSANCE
 UTILISEE

BOITE DE
 DERIVATION

CABLE PLAT WOERTZ LNPE

CABLE PLAT WOERTZ LNPE

BOITIER DE RACCORDEMENT
 WOERTZ

BOITIER DE RACCORDEMENT
 WOERTZ

VERS 1ERE LIGNE
 DU BUS N°2

VERS 2EME LIGNE
 DU BUS N°2

Page suiv. 200c.9

			Date	03.11.2014	SCHAKO (SUISSE) SA 1762 Givisiez		EXEMPLE DE RACCORDEMENT POUR L'ELECTRICIEN	PASSERELLE CONTACT 2 MASTER	=			
			Resp.	S.GIRARD								
			Vérif.									F 200b
Vers.	Modificat.	Date	Nom	Norme	Origine	Remplace:	Remplacé par:	200008_s03a		de 225 Pg		

A

INTERNE AU TABLEAU
 EXTERNE AU TABLEAU

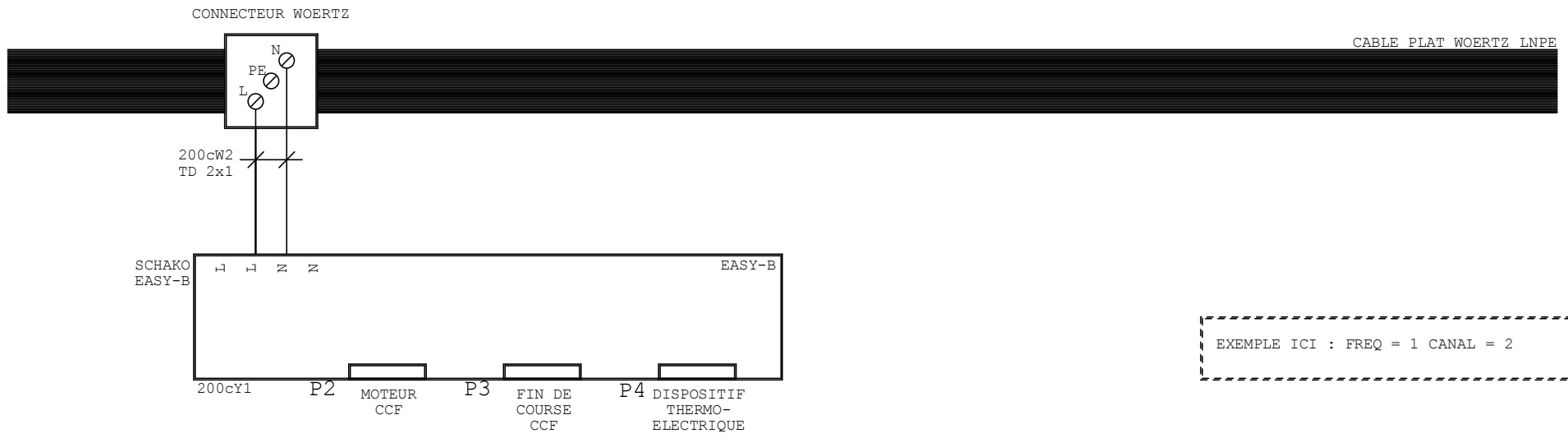

Page suiv. 200d.9

F

			Date	03.11.2014	SCHAKO (SUISSE) SA 1762 Givisiez		EASY-B	PASSERELLE CONTACT 2 MASTER	=				
			Resp.	S.GIRARD									
			Vérif.										
Vers.	Modificat.	Date	Nom	Norme	Origine	Remplace:	Remplacé par:		200008_s03a	F 200c de 225 Pg			

F

A

INTERNE AU TABLEAU
 EXTERNE AU TABLEAU

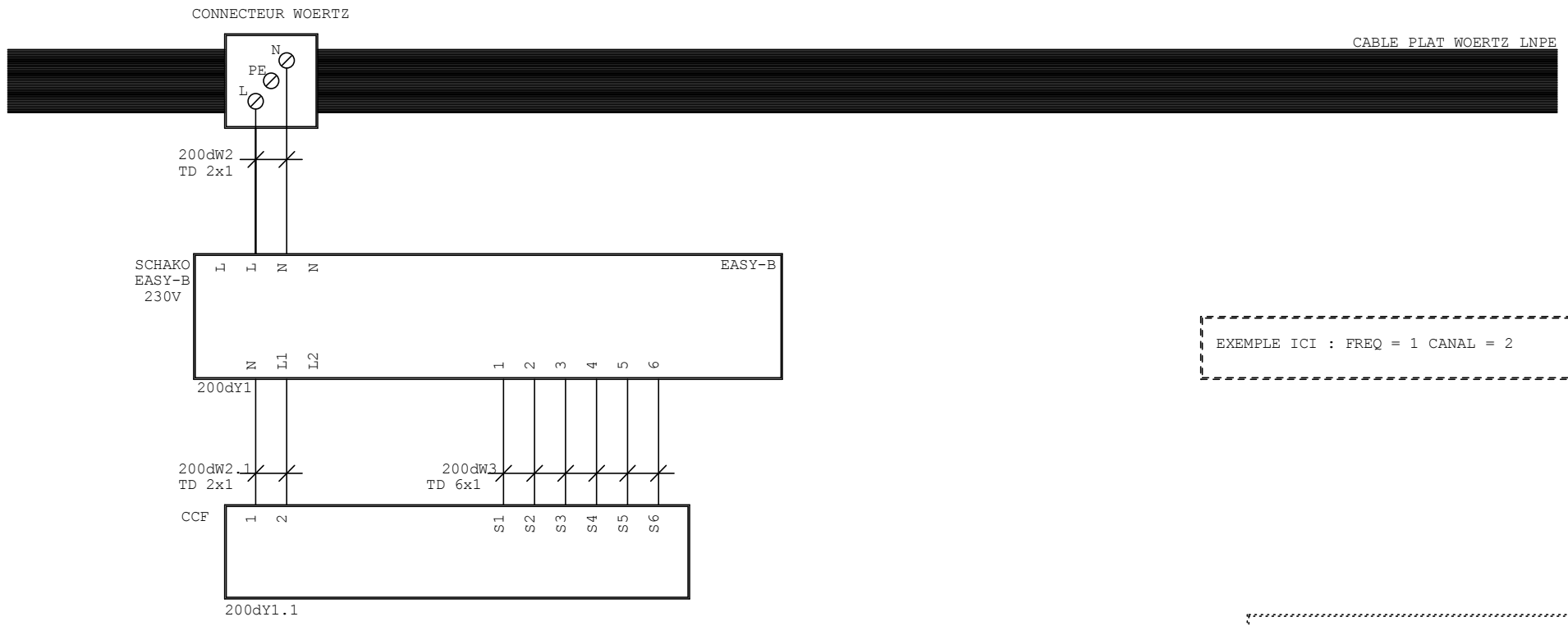

EXEMPLE ICI : FREQ = 1 CANAL = 2

ADRESSE :

Page suiv. 200e.9

F

				Date	03.11.2014	SCHAKO (SUISSE) SA 1762 Givisiez		EASY-B 230V	PASSERELLE CONTACT 2 MASTER	=	F 200d		
				Resp.	S.GIRARD							200008_s03a	de 225Pg
				Vérif.									
Vers.	Modificat.	Date	Nom	Norme		Origine	Remplace:	Remplacé par:					

F

A

INTERNE AU TABLEAU
 EXTERNE AU TABLEAU

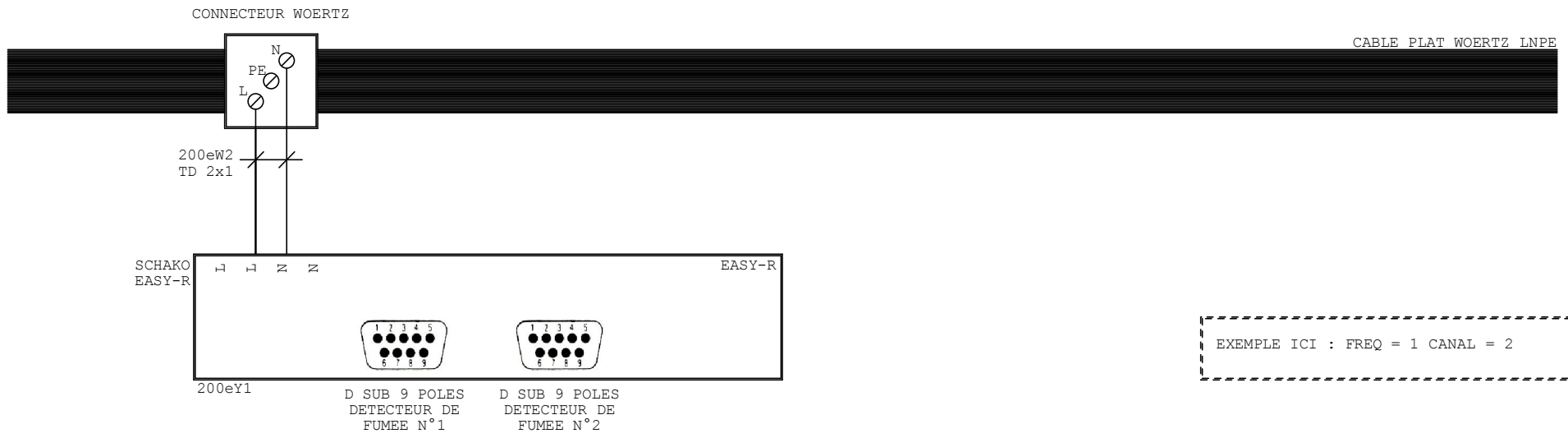

EXEMPLE ICI : FREQ = 1 CANAL = 2

ADRESSE :

Page suiv. 201.9

F

			Date	03.11.2014	SCHAKO (SUISSE) SA			EASY-R	PASSERELLE CONTACT 2 MASTER	=	
			Resp.	S.GIRARD	1762 Givisiez					+	
			Vérif.								
Vers.	Modificat.	Date	Nom	Norme	Origine	Remplace:	Remplacé par:		200008_s03a	F	200e
											de 225 Pg

F

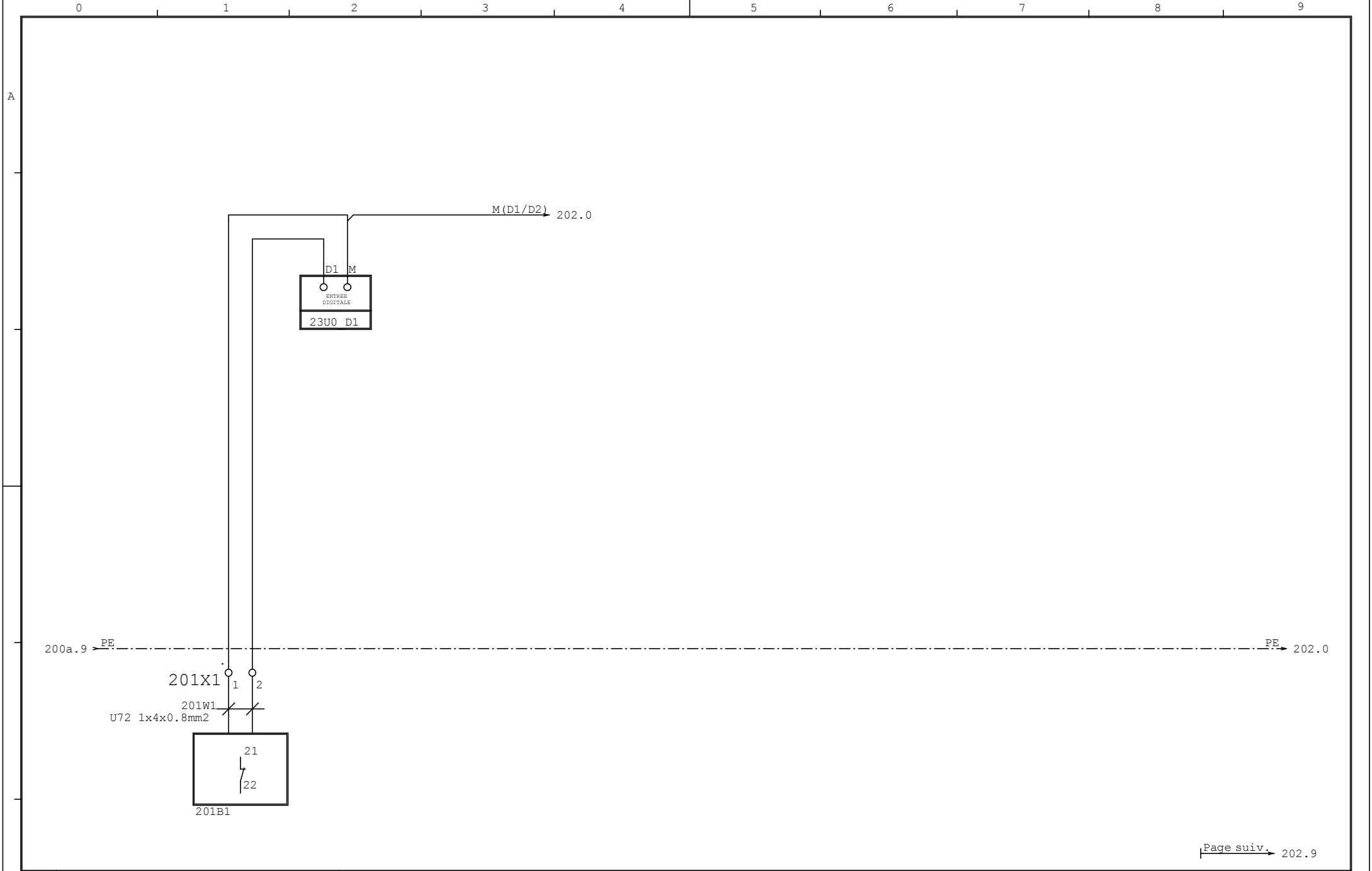

Page suiv. 202.9

				Date	03.11.2014	SCHAKO (SUISSE) SA		ENTREE DIGITALE 1	PASSERELLE CONTACT 2 MASTER	=	F 201				
				Resp.	S.GIRARD							1762 Givisiez	200008_s03a	+	de 225 Pg
				Vérif.											
Vers.	Modificat.	Date	Nom	Norme		Origine	Remplace:	Remplacé par:							

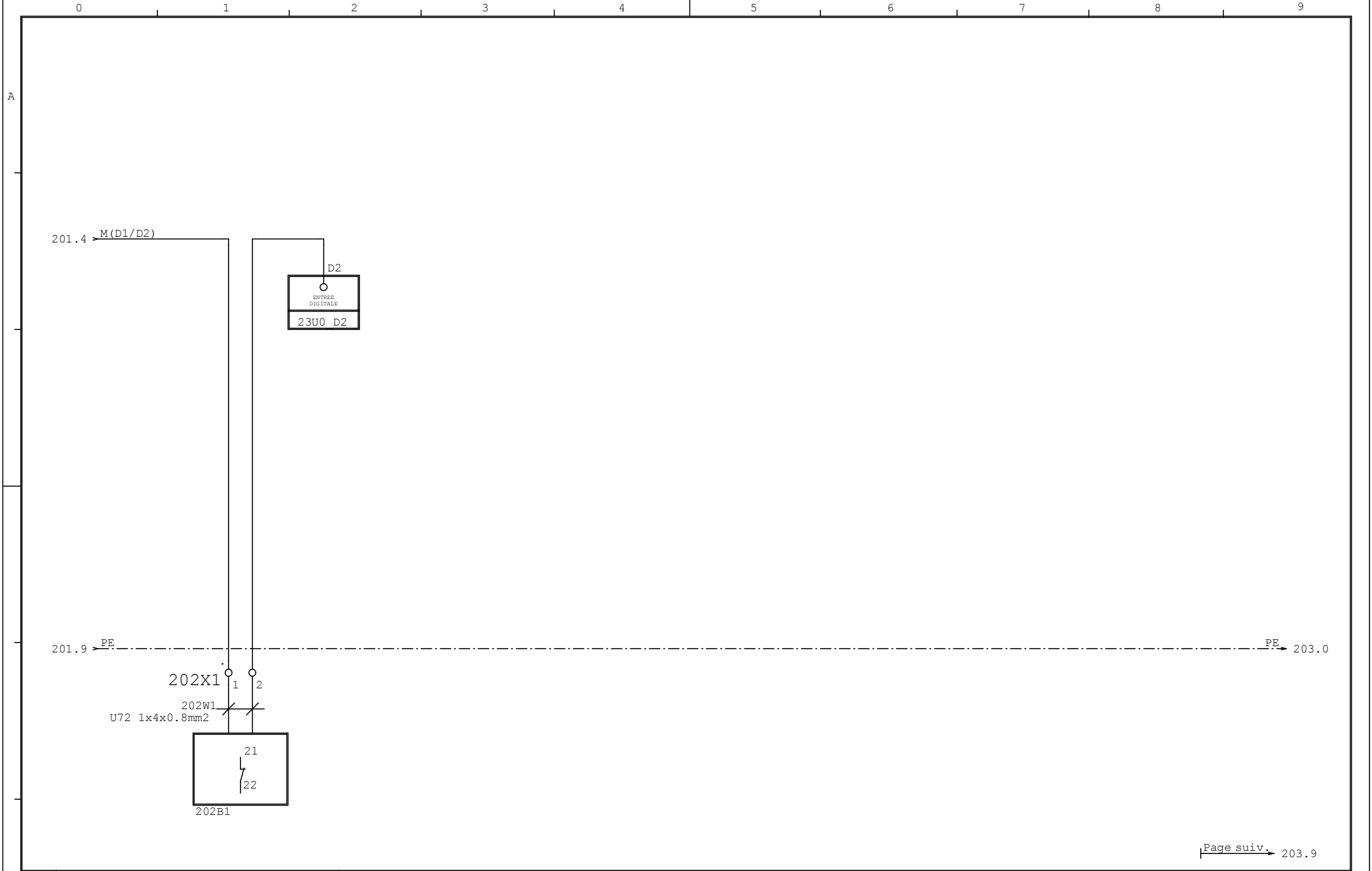

Page suiv. 203.9

				Date	03.11.2014	SCHAKO (SUISSE) SA 1762 Givisiez		ENTREE DIGITALE 2	PASSERELLE CONTACT 2 MASTER	=	
				Resp.	S.GIRARD					+	
				Vérif.							
Vers.	Modificat.	Date	Nom	Norme		Origine	Remplace:	Remplacé par:		200008_s03a	F 202 de 225 Pg

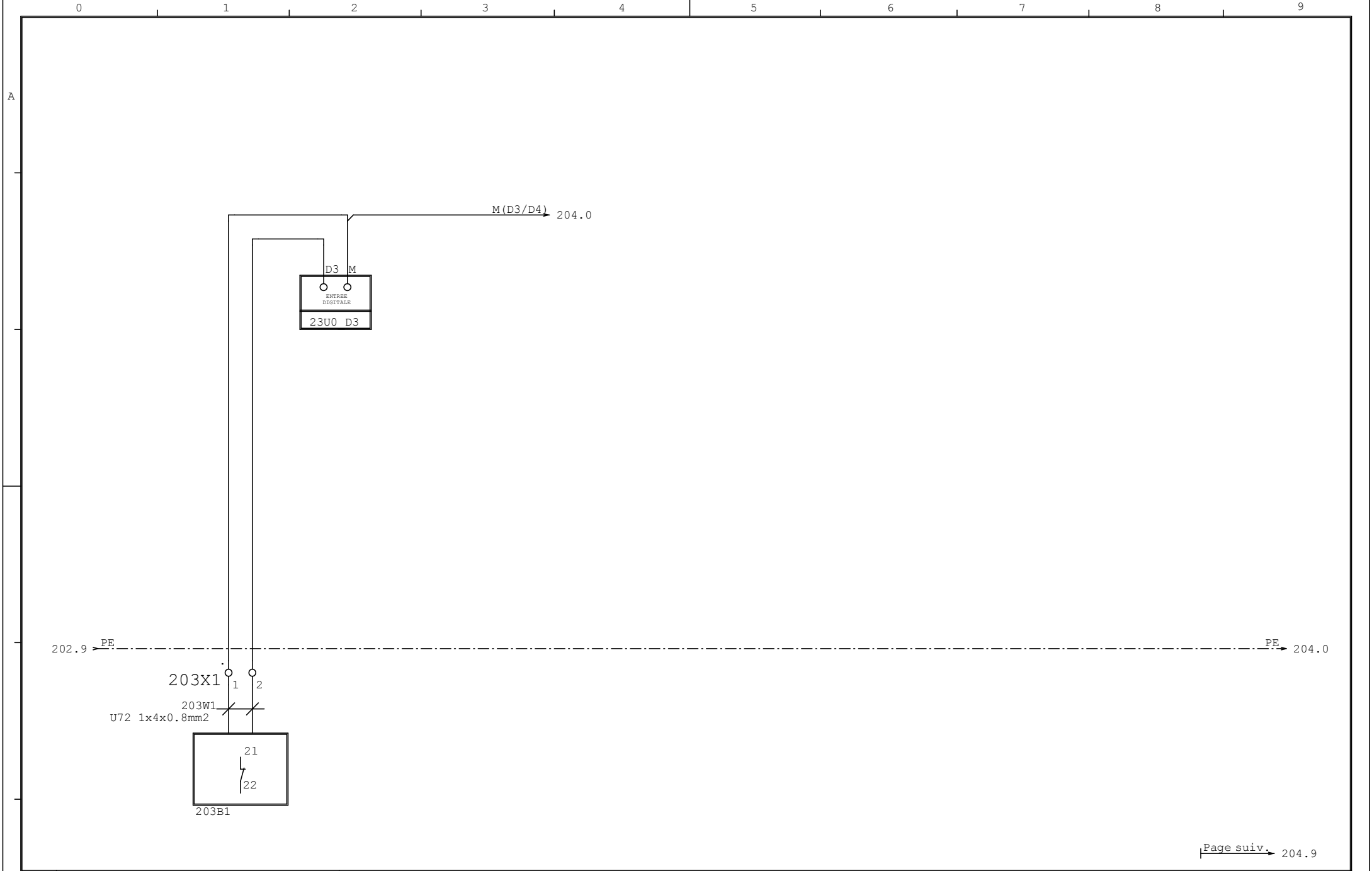

Page suiv. 204.9

				Date	03.11.2014	SCHAKO (SUISSE) SA 1762 Givisiez		ENTREE DIGITALE 3	PASSERELLE CONTACT 2 MASTER	=	
				Resp.	S.GIRARD					+	
				Vérif.							
Vers.	Modificat.	Date	Nom	Norme		Origine	Remplace:	Remplacé par:		200008_s03a	F 203 de 225 Pg

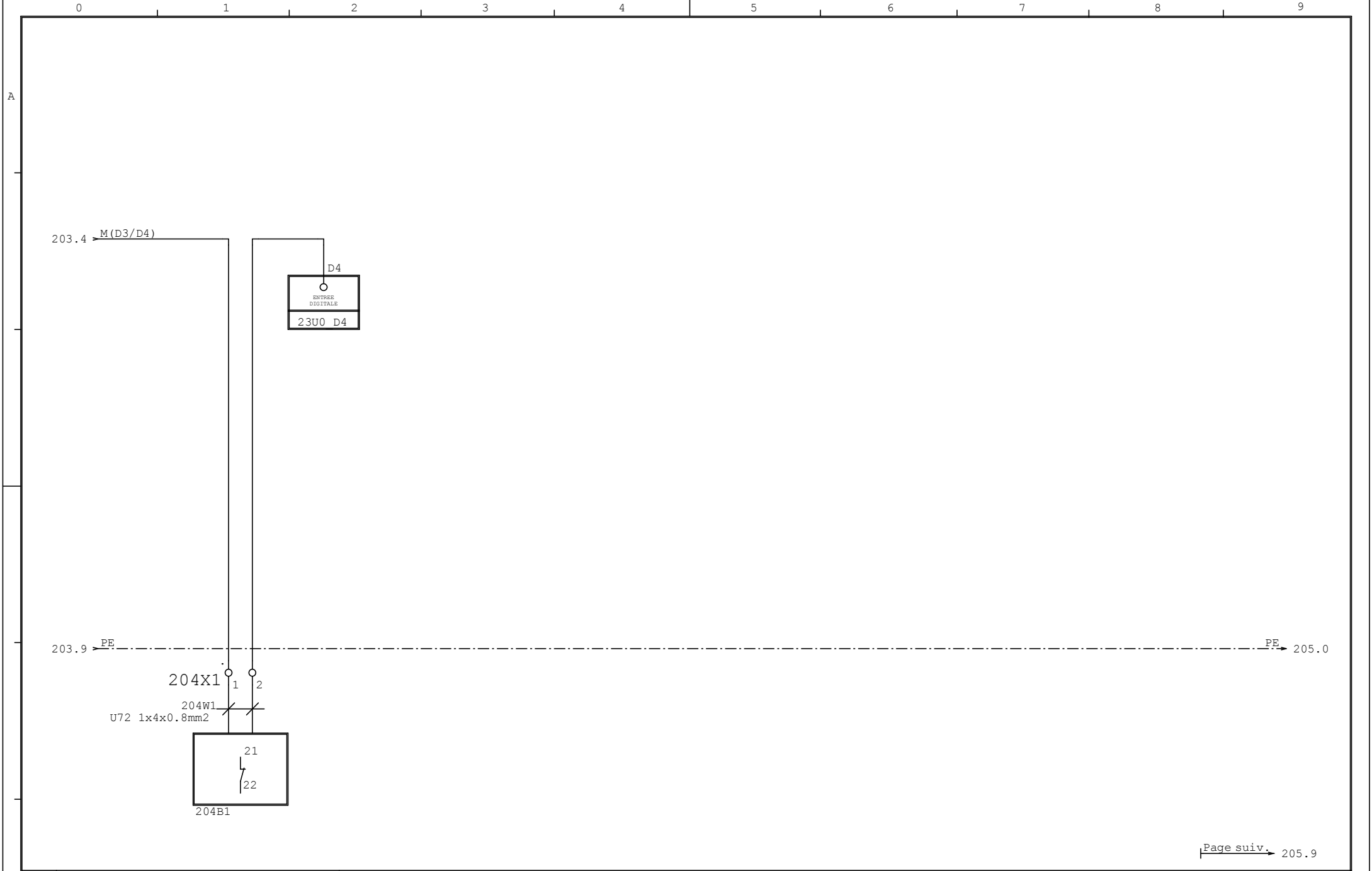

Page suiv. 205.9

			Date	03.11.2014	SCHAKO (SUISSE) SA		ENTREE DIGITALE 4	PASSERELLE CONTACT 2 MASTER	=			
		Resp.	S.GIRARD									
		Vérif.		1762 Givisiez								
Vers.	Modificat.	Date	Nom	Norme	Origine	Remplace:	Remplacé par:		200008_s03a	F 204 de 225 Pg		

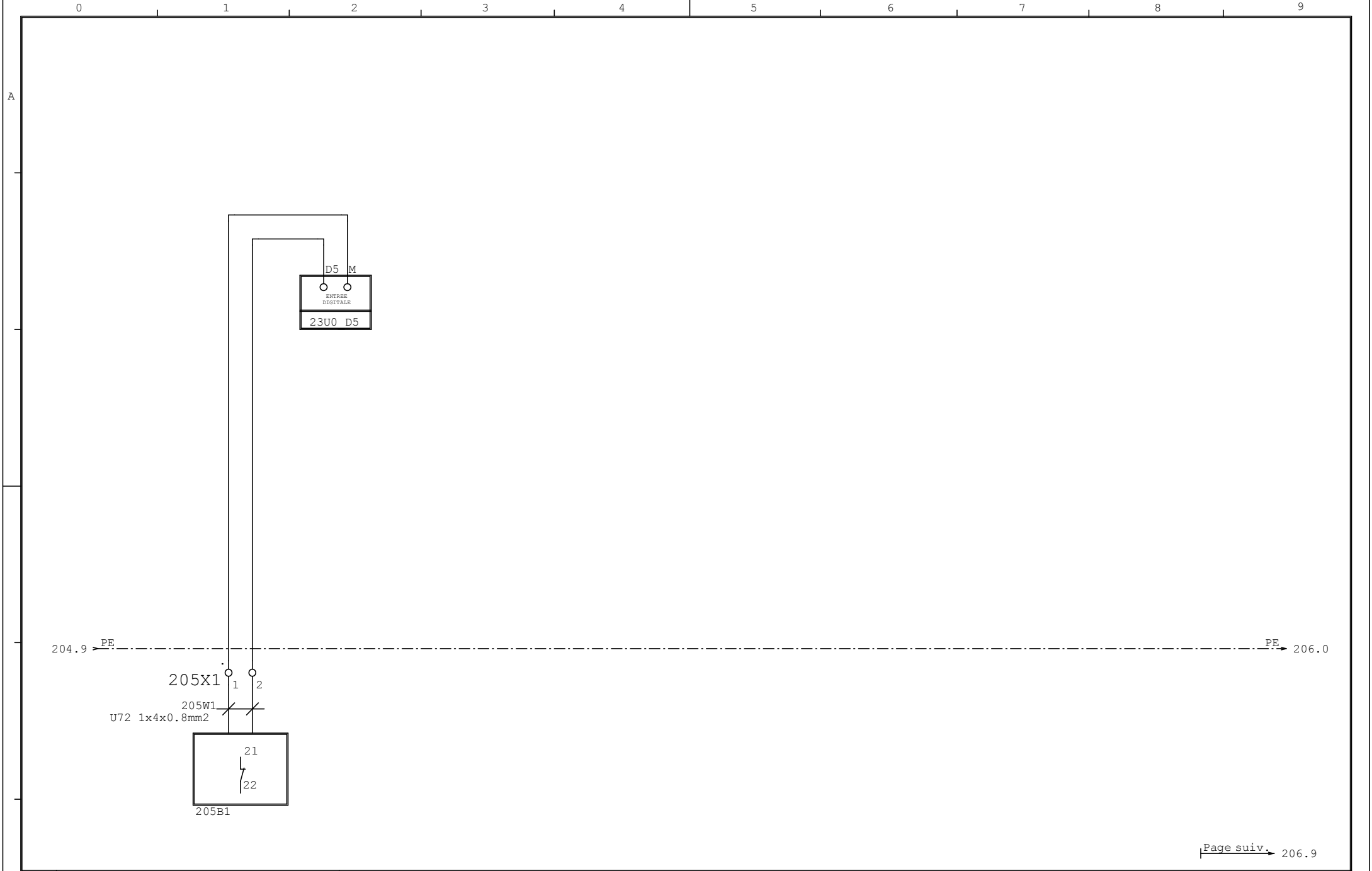

Page suiv. 206.9

			Date	03.11.2014	SCHAKO (SUISSE) SA 1762 Givisiez		ENTREE DIGITALE 5	PASSERELLE CONTACT 2 MASTER	=				
		Resp.	S.GIRARD	+									
		Vérif.											
Vers.	Modificat.	Date	Nom	Norme	Origine	Remplace:	Remplacé par:	200008_s03a	F	205			
0			1		2	3	4	5	6	7	8	9	F

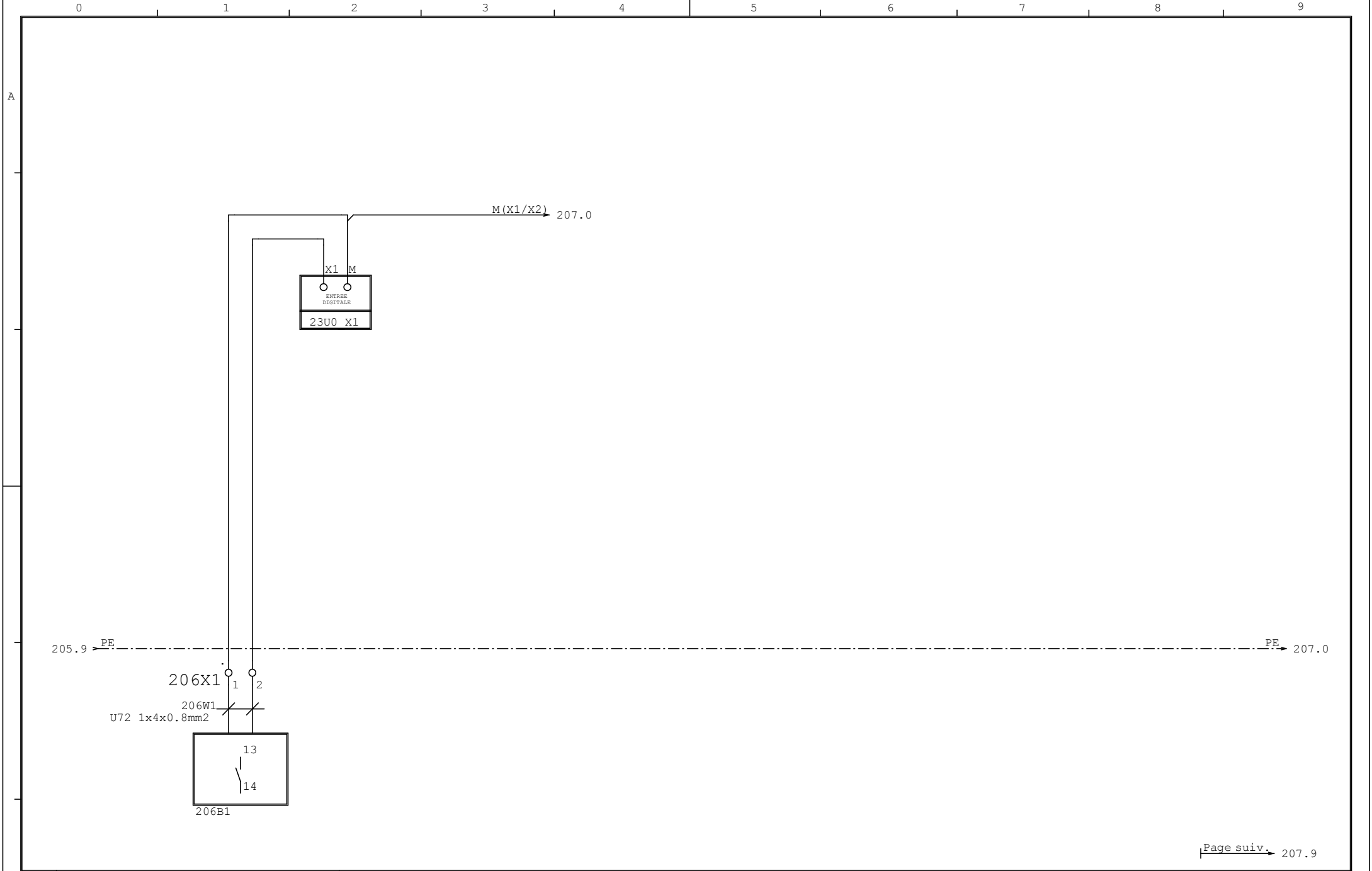

Page suiv. 207.9

			Date	03.11.2014	SCHAKO (SUISSE) SA 1762 Givisiez		ENTREE DIGITALE 6	PASSERELLE CONTACT 2 MASTER	=	
		Resp.	S.GIRARD	+						
		Vérif.								
Vers.	Modificat.	Date	Nom	Norme	Origine	Remplace:	Remplacé par:		200008_s03a	F 206 de 225 Pg

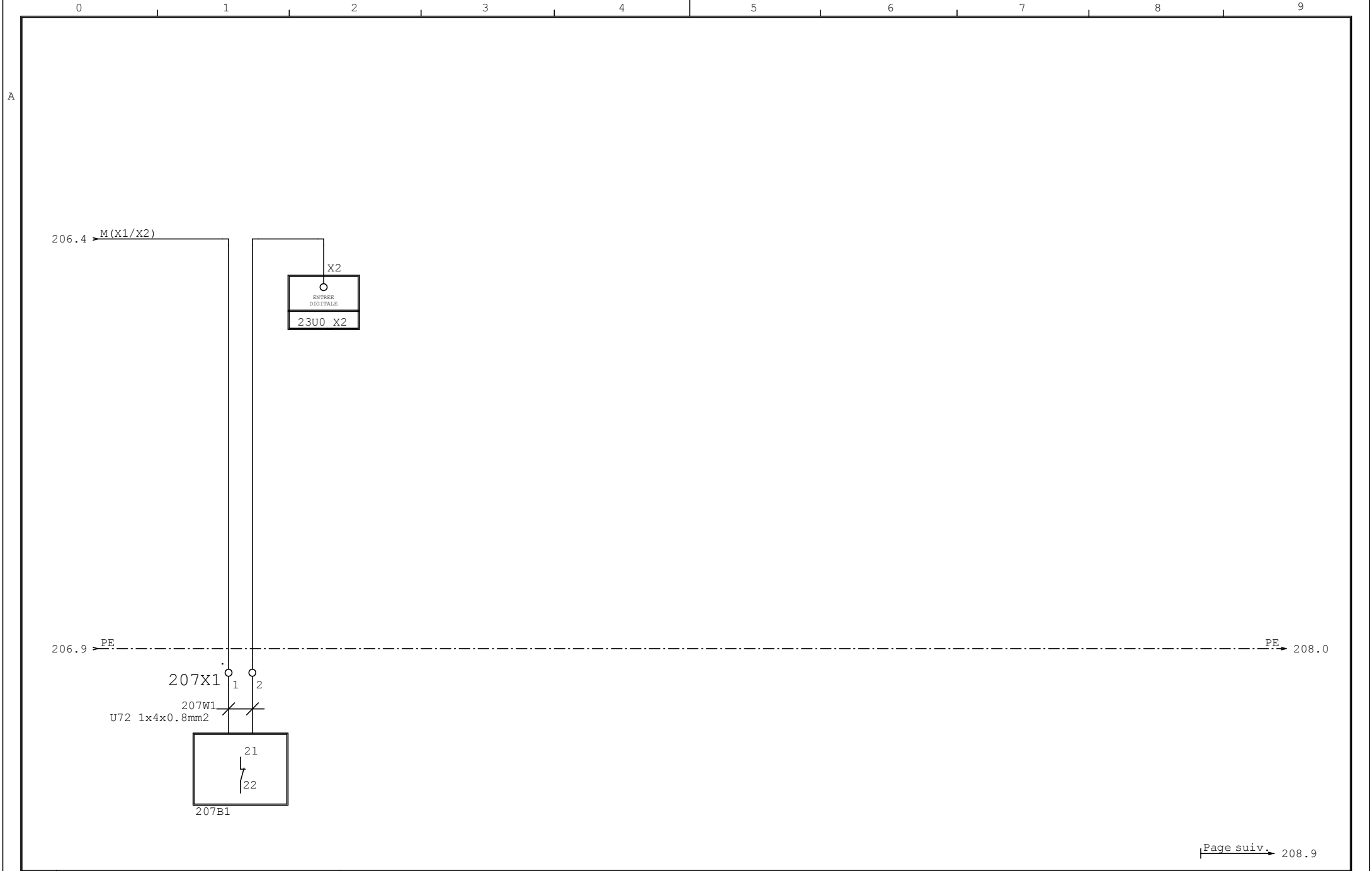

Page suiv. 208.9

				Date	03.11.2014	SCHAKO (SUISSE) SA 1762 Givisiez		ENTREE DIGITALE 7	PASSERELLE CONTACT 2 MASTER	=	
				Resp.	S.GIRARD					+	
				Vérif.							
Vers.	Modificat.	Date	Nom	Norme		Origine	Remplace:	Remplacé par:		200008_s03a	F 207 de 225 Pg

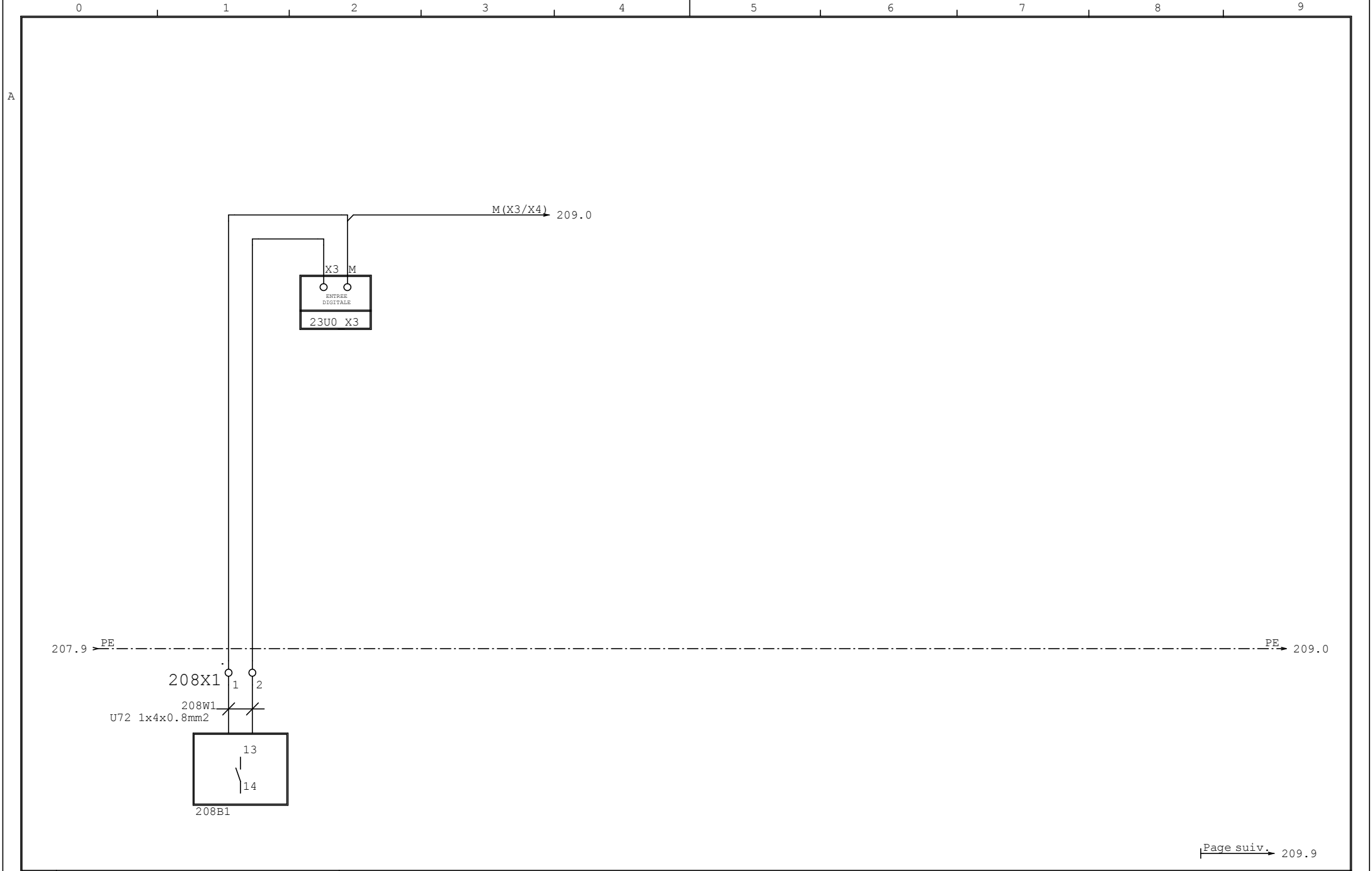

Page suiv. 209.9

			Date	03.11.2014	SCHAKO (SUISSE) SA 1762 Givisiez		ENTREE DIGITALE 8	PASSERELLE CONTACT 2 MASTER	=	
		Resp.	S.GIRARD	+						
		Vérif.								
Vers.	Modificat.	Date	Nom	Norme	Origine	Remplace:	Remplacé par:		200008_s03a	F 208 de 225 Pg

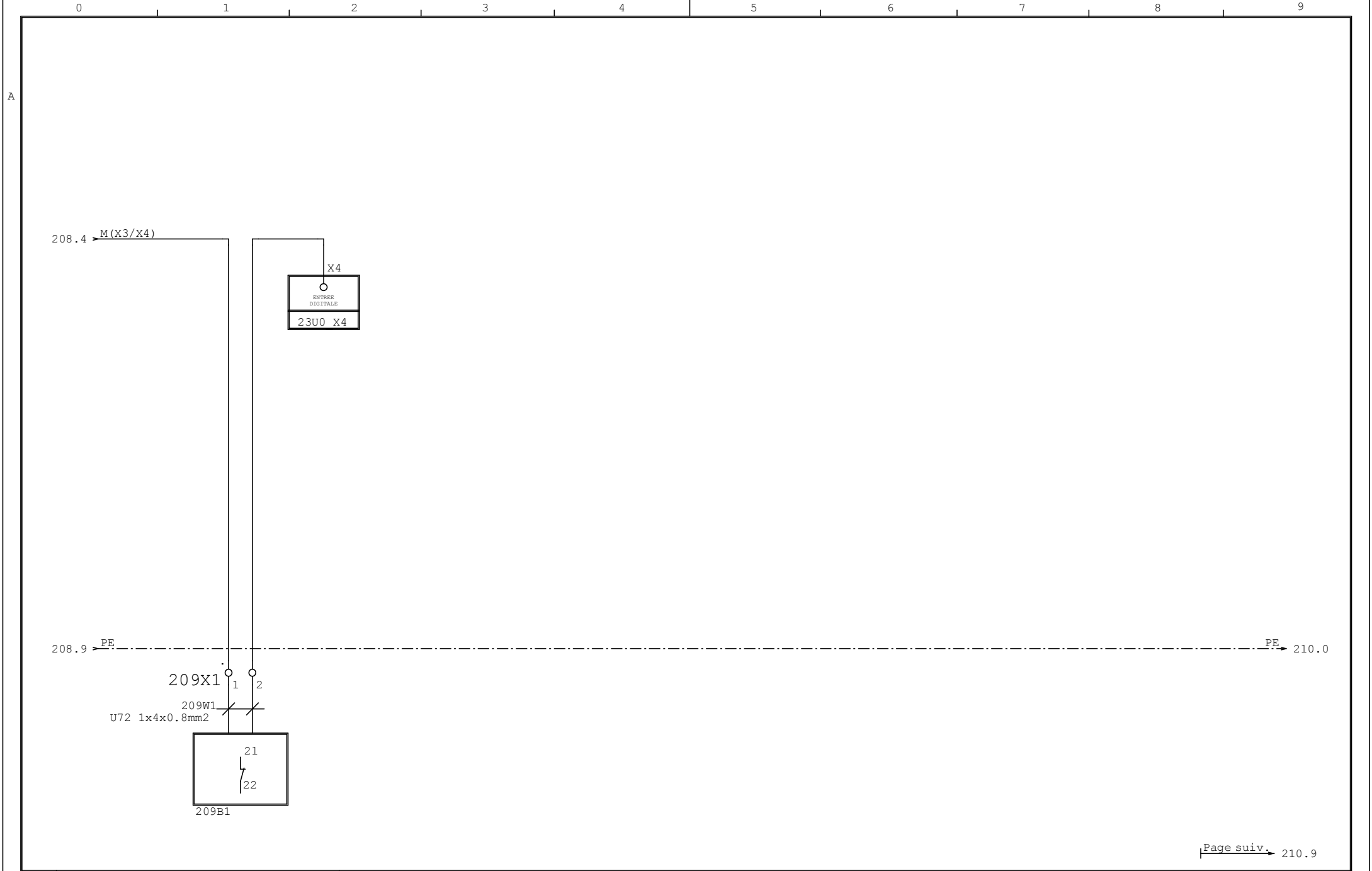

Page suiv. 210.9

				Date	03.11.2014	SCHAKO (SUISSE) SA		ENTREE DIGITALE 9	PASSERELLE CONTACT 2 MASTER	=				
				Resp.	S.GIRARD									
				Vérif.						1762 Givisiez				
Vers.	Modificat.	Date	Nom	Norme		Origine	Remplace:	Remplacé par:		200008_s03a	F 209 de 225 Pg			

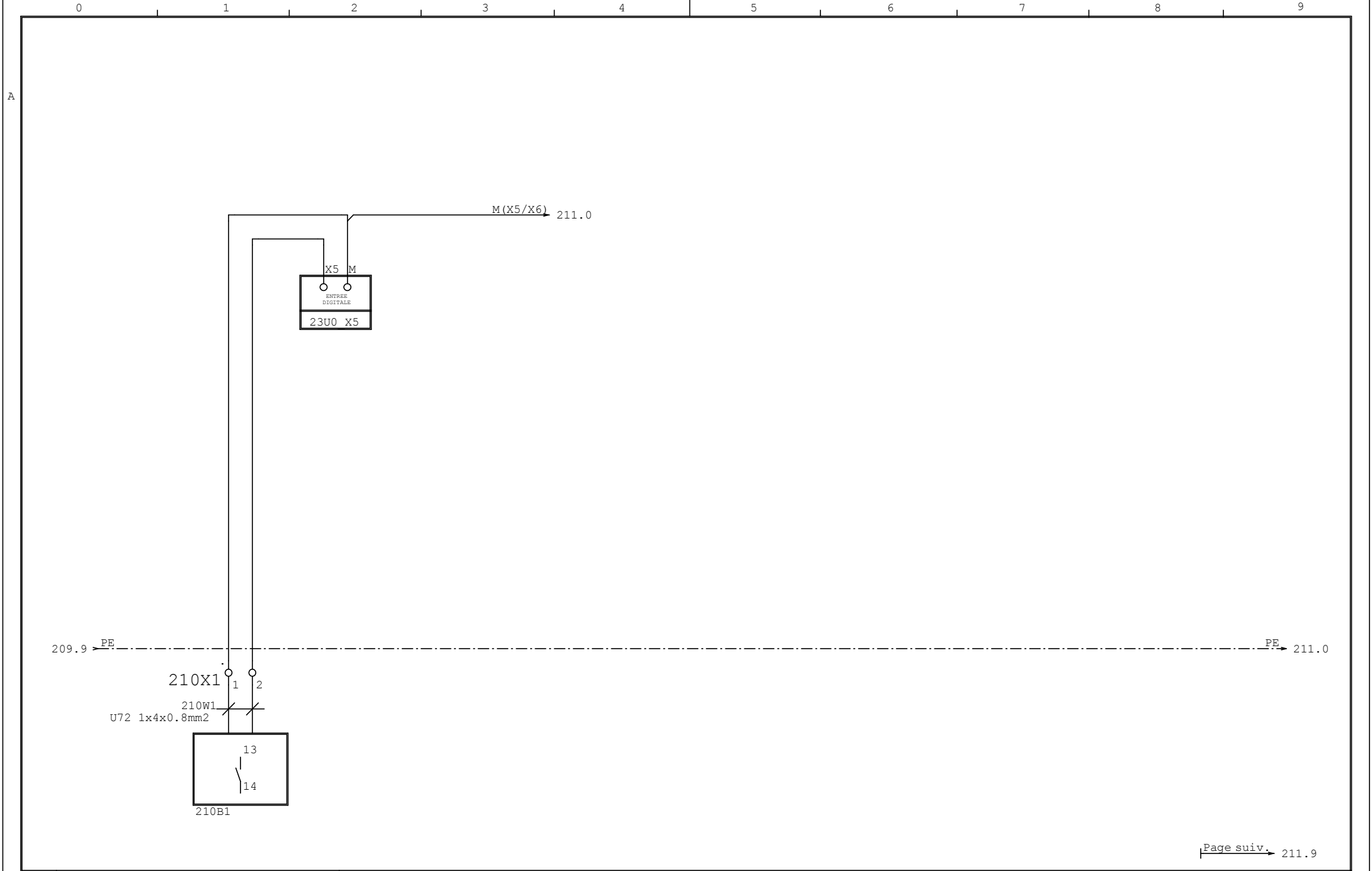

Page suiv. 211.9

				Date	03.11.2014	SCHAKO (SUISSE) SA		ENTREE DIGITALE 10	PASSERELLE CONTACT 2 MASTER	=				
				Resp.	S.GIRARD									
				Vérif.						1762 Givisiez				
Vers.	Modificat.	Date	Nom	Norme		Origine	Remplace:	Remplacé par:		200008_s03a	F 210 de 225 Pg			

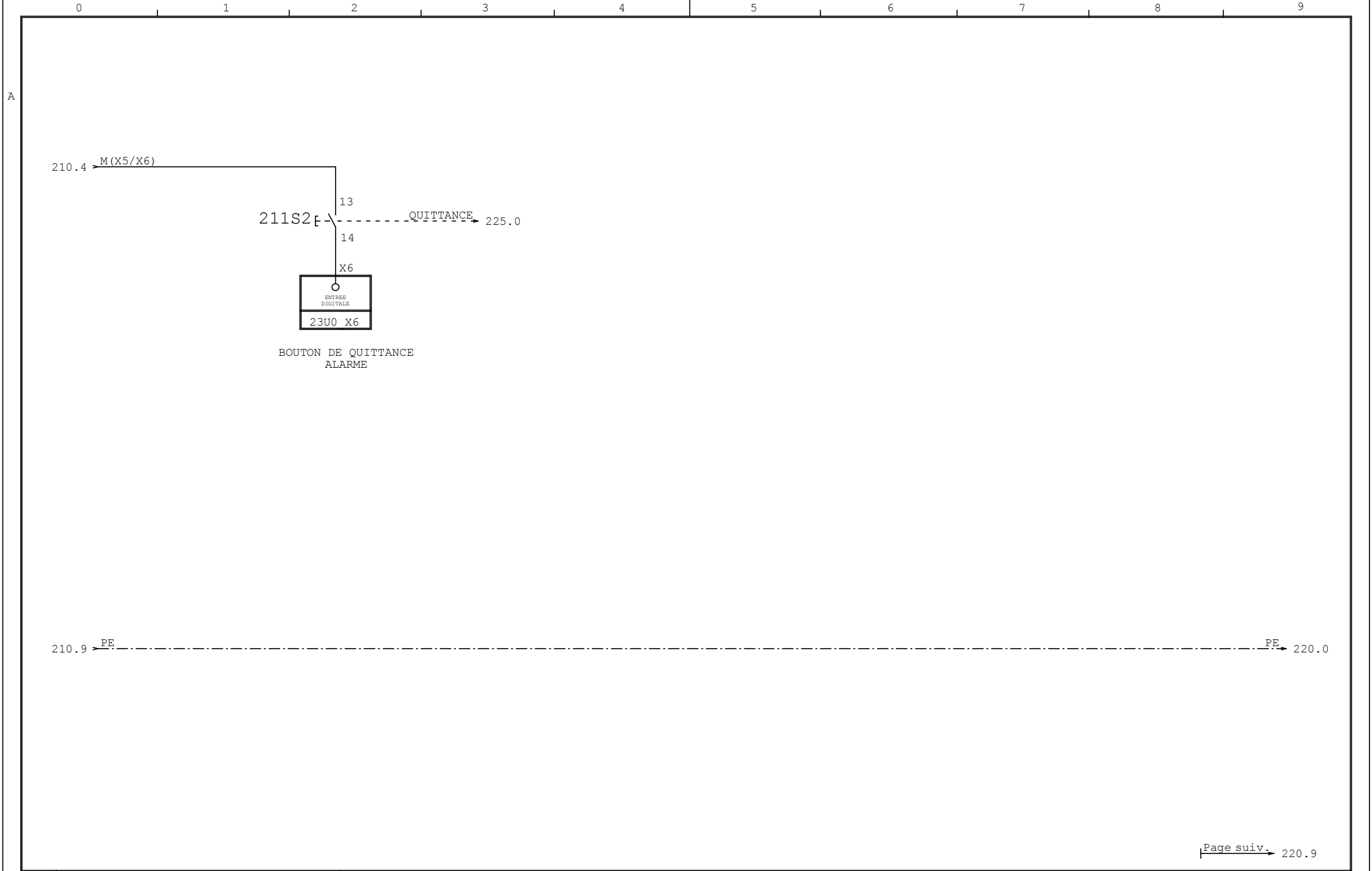

Page suiv. 220.9

				Date	03.11.2014	SCHAKO (SUISSE) SA			ENTREE DIGITALE 11	PASSERELLE CONTACT 2 MASTER	=		
				Resp.	S.GIRARD	1762 Givisiez			BOUTON DE			+	
				Vérif.					QUITTANCE ALARME				F 211
Vers.	Modificat.	Date	Nom	Norme		Origine	Remplace:	Remplacé par:		200008_s03a		de 225 Pg	

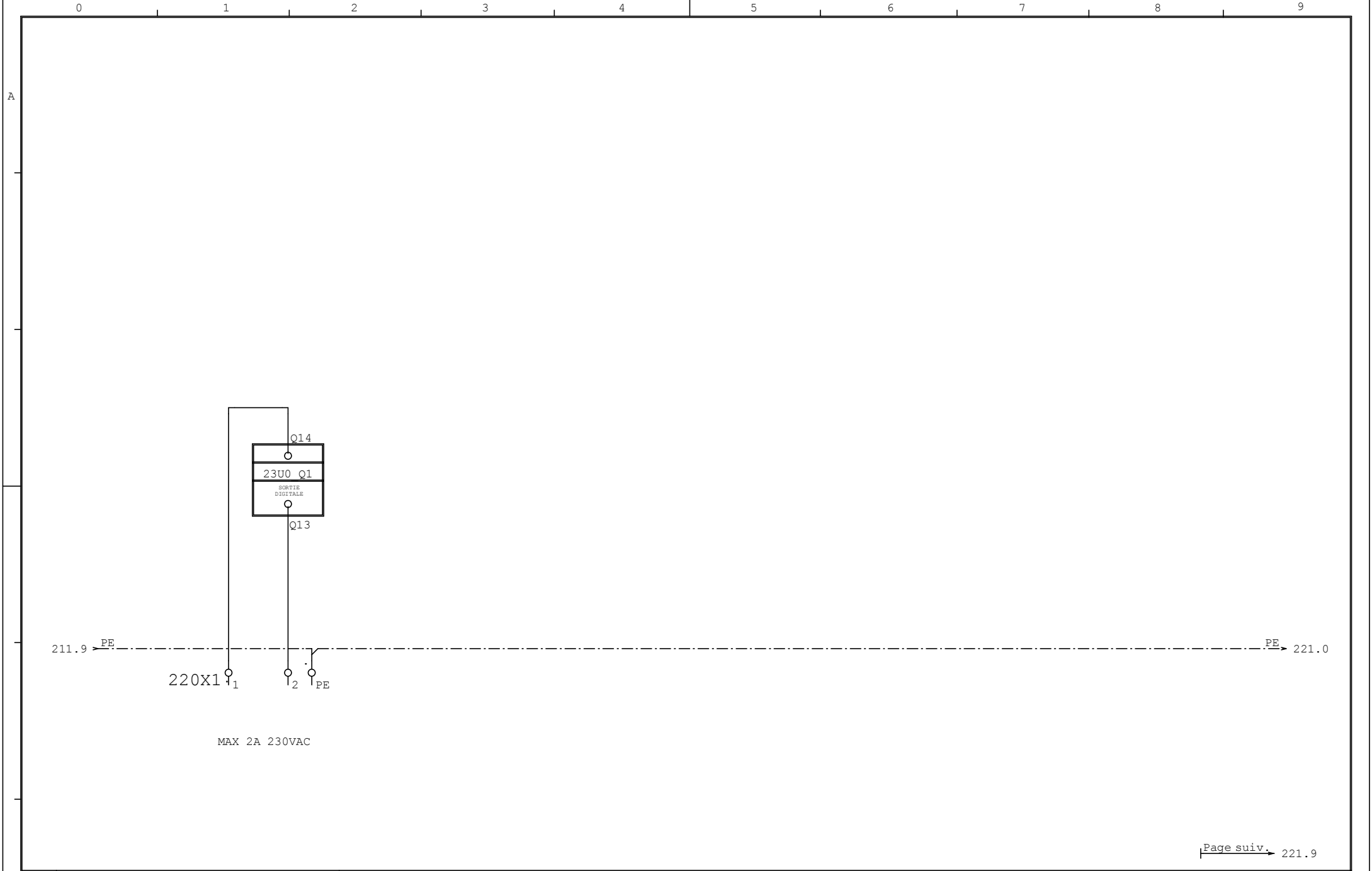

Page suiv. 221.9

				Date	03.11.2014	SCHAKO (SUISSE) SA		SORTIE DIGITALE 1	PASSERELLE CONTACT 2 MASTER	=			
				Resp.	S.GIRARD								
				Vérif.						1762 Givisiez			
Vers.	Modificat.	Date	Nom	Norme		Origine	Remplace:	Remplacé par:		200008_s03a	F 220 de 225 Pg		

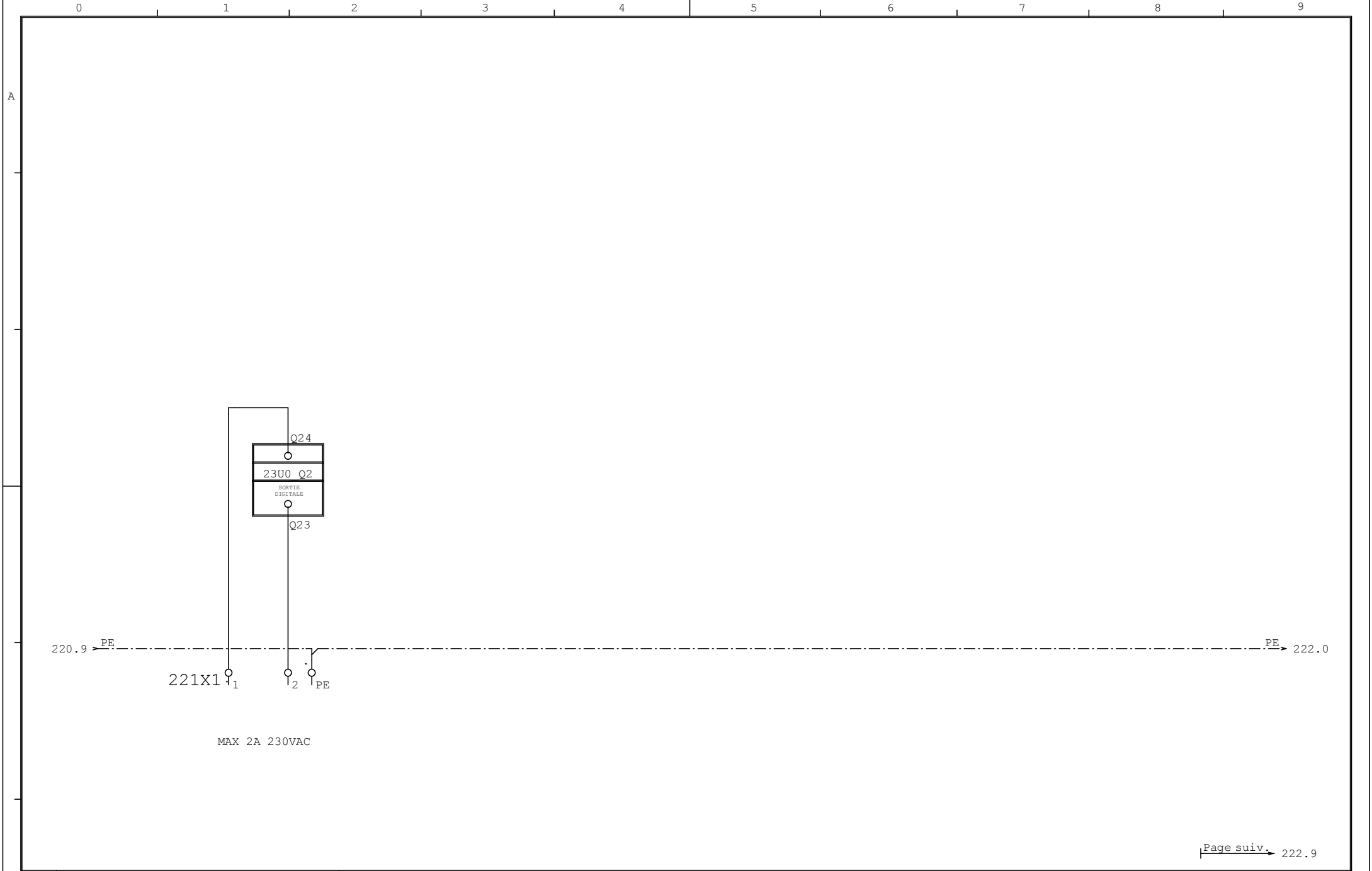

Page suiv. 222.9

			Date	03.11.2014	SCHAKO (SUISSE) SA			SORTIE DIGITALE 2		PASSERELLE CONTACT 2 MASTER	=	
			Resp.	S.GIRARD	1762 Givisiez						+	
			Vérif.									F
Vers.	Modificat.	Date	Nom	Norme	Origine	Remplace:	Remplacé par:			200008_s03a		de 225 Pg

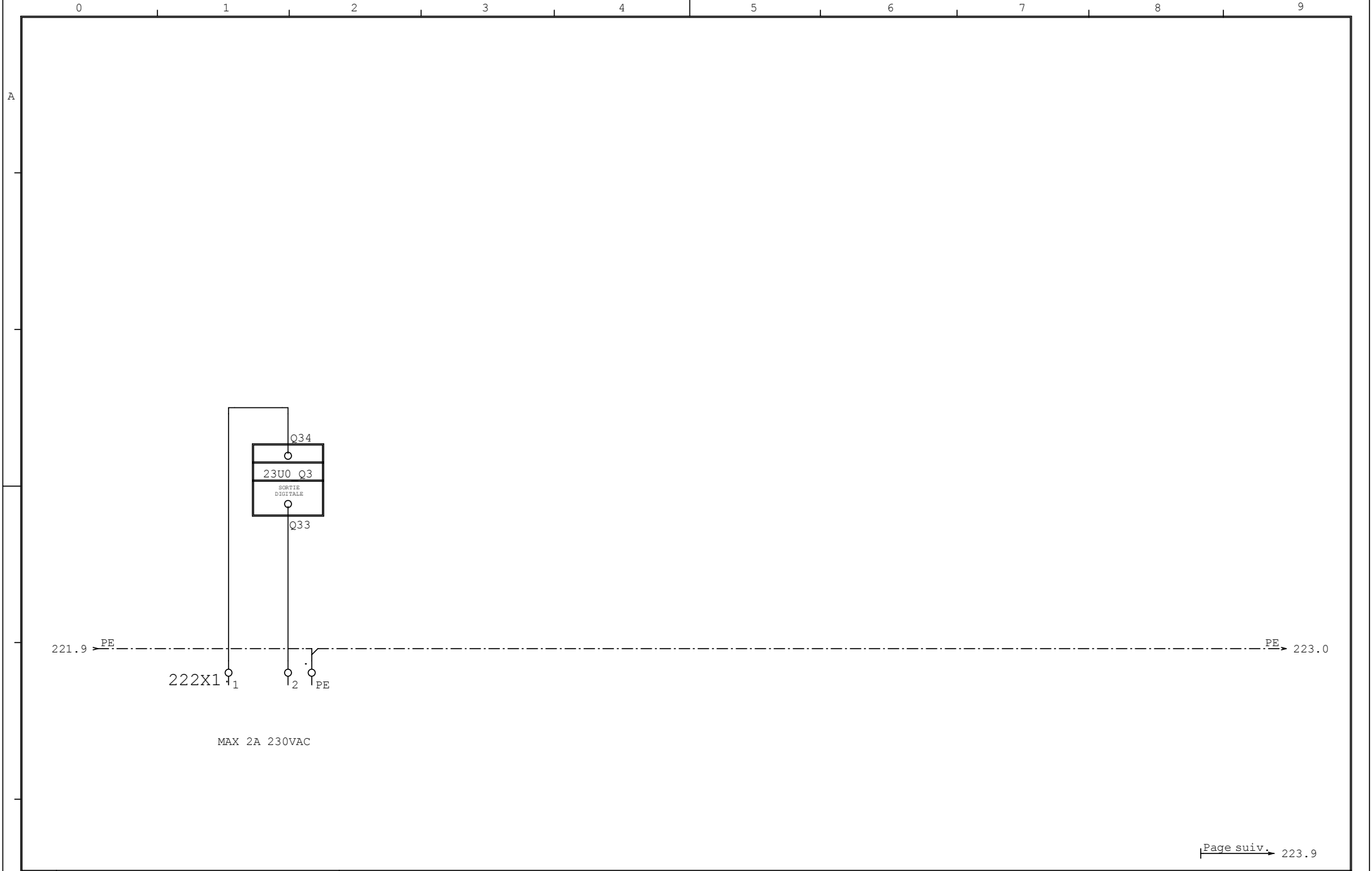

Page suiv. 223.9

			Date	03.11.2014	SCHAKO (SUISSE) SA			SORTIE DIGITALE 3	PASSERELLE CONTACT 2 MASTER	=	
			Resp.	S.GIRARD	1762 Givisiez					+	
			Vérif.								F 222
Vers.	Modificat.	Date	Nom	Norme	Origine	Remplace:	Remplacé par:		200008_s03a		de 225 Pg

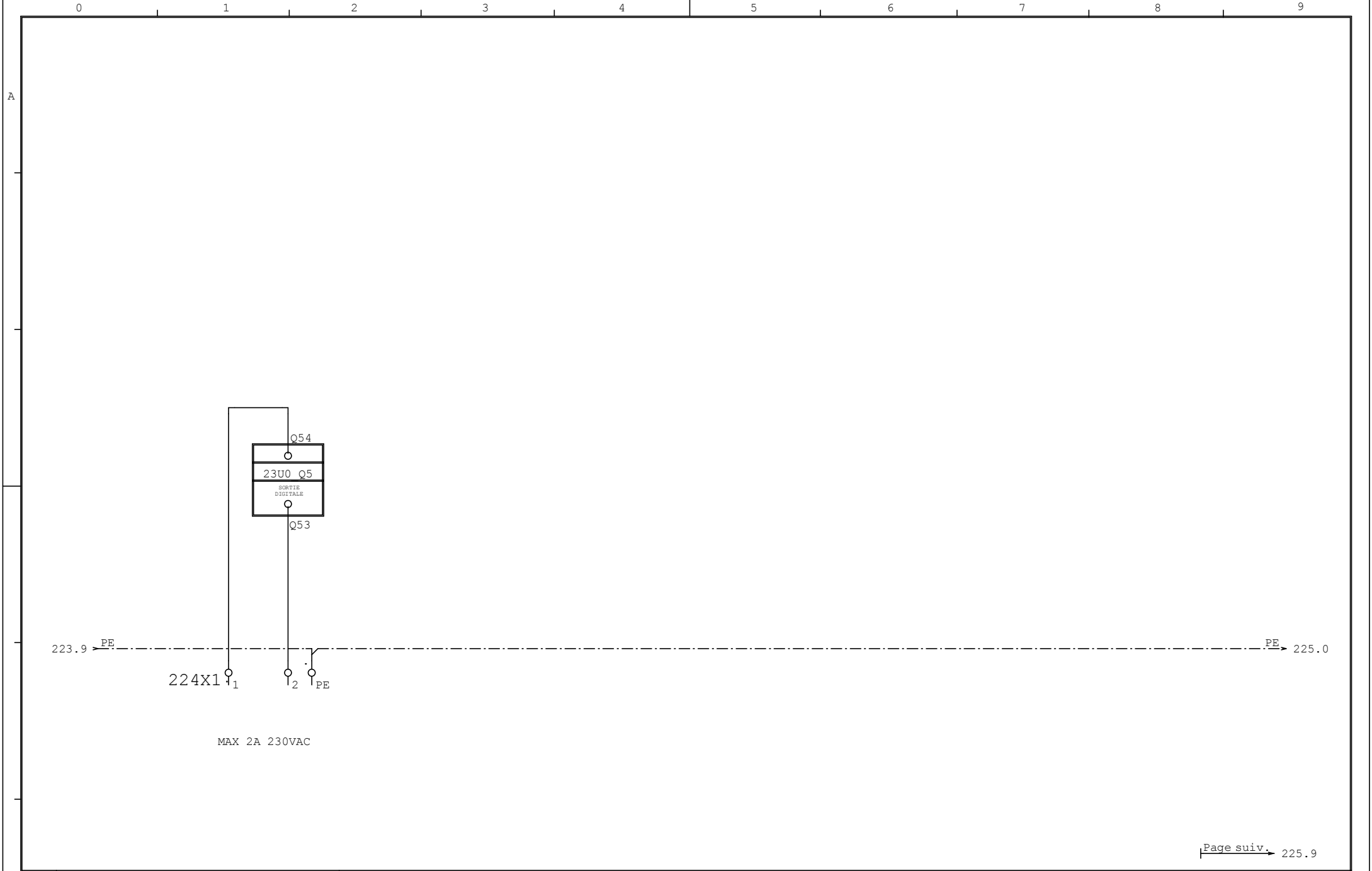

Page suiv. 225.9

				Date	03.11.2014	SCHAKO (SUISSE) SA		SORTIE DIGITALE 5	PASSERELLE CONTACT 2 MASTER	=			
				Resp.	S.GIRARD								
				Vérif.						1762 Givisiez			
Vers.	Modificat.	Date	Nom	Norme		Origine	Remplace:	Remplacé par:		200008_s03a	de 225 Pg		

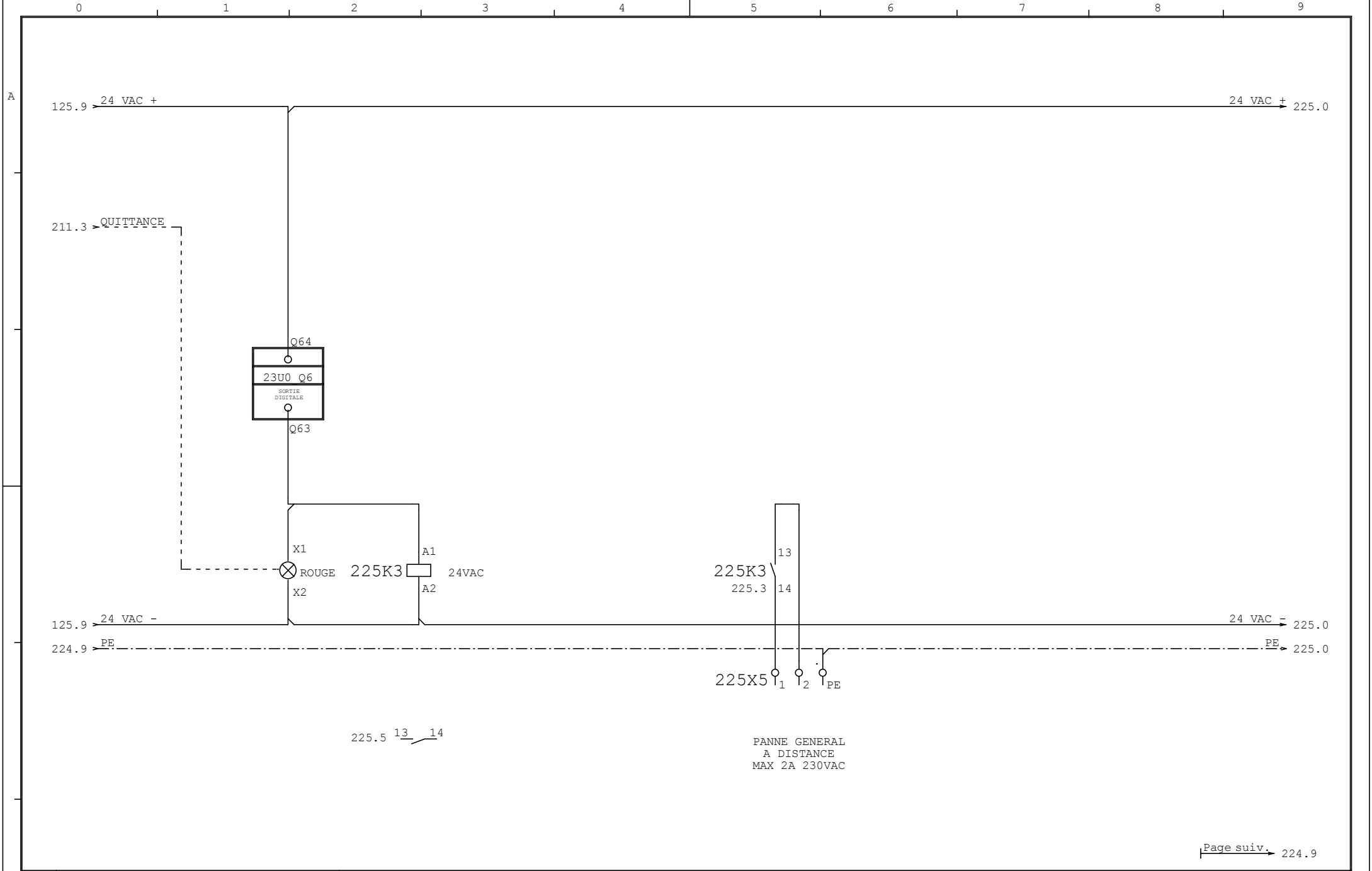

Page suiv. 224.9

				Date	03.11.2014	SCHAKO (SUISSE) SA			SORTIE DIGITALE 6		PASSERELLE CONTACT 2 MASTER		=
				Resp.	S.GIRARD	1762 Givisiez			PANNE GENERAL				+
				Vérif.					A DISTANCE				F 225
Vers.	Modificat.	Date	Nom	Norme	Origine	Remplace:	Remplacé par:	200008_s03a				de 225 Pg	