

KUNDE : INTEGRATOR

VERSION 1

PROJEKT : EASYBUS



BÜRO : SCHAKO SUISSE SA
RUE JEAN PROUVE 28
1762 GIVISIEZ

TEL : 026 460 88 00 FAX: 026 460 88 05

DIESES SCHEMA IST GEISTIGES
EIGENTUM VON SCHAKO

ÄNDERUNGEN ODER ANPASSUNGEN
SIND OHNE UNSERE
AUSDRÜCKLICHE ZUSTIMMUNG
NICHT ERLAUBT

DAS EMPFOHLENE MATERIAL
MUSS GEMÄSS VORSCHRIFT
DES HERSTELLERS
MONTIERT WERDEN

DIE AUFGEFÜHRTEN KONTAKTE
SIND OHNE SPANNUNG
ANGEGEBEN

DIEMENSIONIEREN SIE DAS
ANSCHLUSSKABEL LAUT
ANGABEN DES
ENERGIVERSORGERS

INSTALLATION:

STROMANSCHLUSS SCHEMA

REV	NAME	DATUM	REV	NAME	DATE
1	LOCHER D.	21.05.2014			

Nächste S. 10.9

		Datum	21.01.2015	SCHAKO (SUISSE) SA			VORSATZBLATT	STROMANSCHLUSS SCHEMA	=		
		Verant.	D. LOCHER	1762 Givisiez						+	
		Kontr.		Original			Ersetzt von:		200008_s01a		Folio 1
Vers.	Modifikat.	Datum	Name	Norme						von 21S.	

EASYBUS

BSK RAUCHABZUG VSR

Nächste S. 11.9

		Datum	21.01.2015	SCHAKO (SUISSE) SA			EASYBUS	STROMANSCHLUSS SCHEMA		=
		Verant.	D. LOCHER	1762 Givisiez						+
		Kontr.		Original			Ersetzt:	Ersetzt von:	200008_S01a	
Vers.	Modifikat.	Datum	Name	Norme	Original	Ersetzt:	Ersetzt von:			

11a.9 L
 11a.9 N
 11a.9 PE

L → 11a.0
 N → 11a.0
 PE → 11a.0

AM AUTOMAT
 RS-485 / 232
 MODBUS RTU
 BAUDRATE=19200
 BITS=8-E-2
 ADRESSE=1

0V MOD1
 D MOD1
 /D MOD1



EINSEITIG
 GEERDETE
 ABSCHIRMUNG

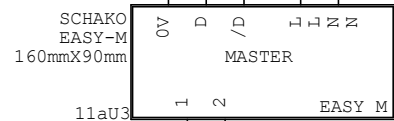

KABEL TD 3X2.5MM2
 PE DRAHT NUR
 AM FILTER
 ANSCHLIESSEN

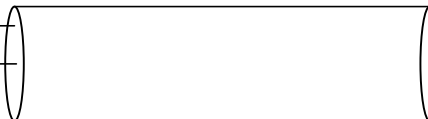

11aF6
 C13A

SCHAKO
 EASY-F
 200mmX150mm

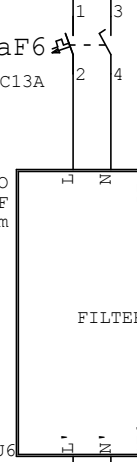

DER FILTER MUSS MINIMAL > 50CM
 EINEM FREQUENZVARIATOR
 INSTALLIERT WERDEN

11aU6

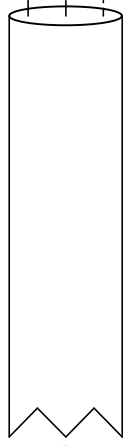

KABEL DIREKT AM FILTER
 ANSCHLIESSEN. ZWISCHEN DIE
 ANSCHLUSSDOSE UND DEN FILTER
 MÜSSEN KEINE KLEMMEN
 ANGESCHLOSSEN WERDEN.
 MINIMUM 3X2.5MM2

KABEL NACH LEISTUNG
 DIMENSIONIEREN

! WENN MEHRERE MASTER DAN
 KANNÄLE AM MASTER UND AN
 SEINEM EASYBUS NETZ WECHSELN

BEISPIEL HIER : FREQ = 1 CANAL = 1

INTERN SCHALTSCHRANK
 EXTERN SCHALTSCHRANK

WEITER ZUR SEITE 11b
 ANSCHLUSSBEISPIEL
 FÜR DEN ELEKTRIKER

Nächste S. 11b.9

Datum	21.01.2015	SCHAKO (SUISSE) SA			EASY-M MASTER (MA-7-128 MB RTU)	STROMANSCHLUSS SCHEMA	=
Verant.	D. LOCHER	1762 Givisiez					+
Kontr.		Original	Ersetzt:	Ersetzt von:		200008_s01a	Folio 11a von 21S.

INTERN SCHALTSCHRANK
 EXTERN SCHALTSCHRANK

WEITER ZUR SEITE 11a NACH FILTER

**ANSCHLUSSBEISPIEL
 FÜR DEN ELEKTRIKER**

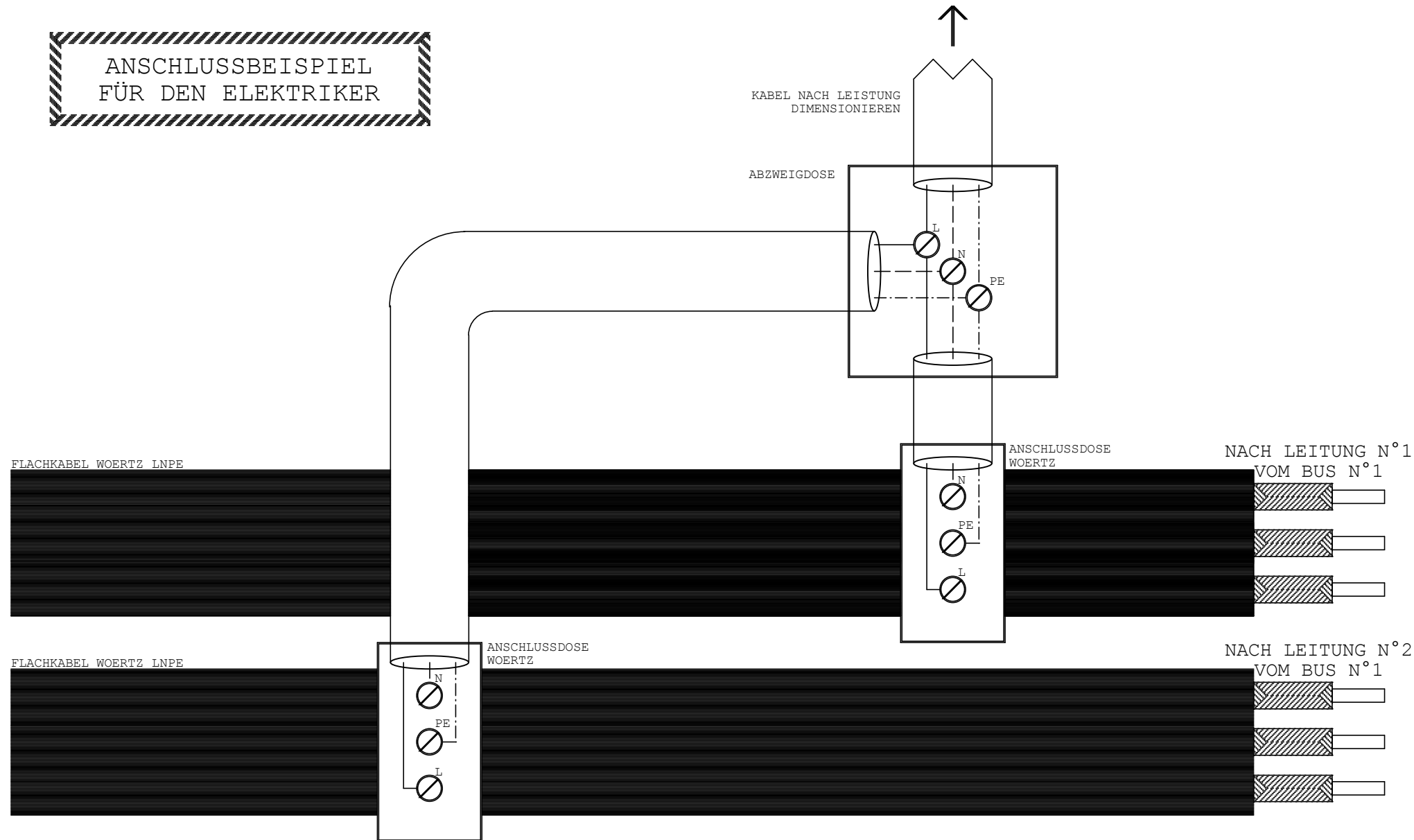

Nächste S. 12.9

Date	21.01.2015	SCHAKO (SUISSE) SA 1762 Givisiez		ANSCHLUSSBEISPIEL FÜR DEN ELEKTRIKER	STROMANSCHLUSS SCHEMA	200008_s01a	F 11b de 21Pg
Resp.	D. LOCHER						
Vérif.							
Vers.	Modificat.	Date	Nom	Norme	Origine	Remplace:	Remplacé par:

INTERN SCHALTSCHRANK
 EXTERN SCHALTSCHRANK



ADRESSE :

Nächste S. 13.9

			Datum	21.01.2015	SCHAKO (SUISSE) SA			STROMANSCHLUSS SCHEMA		=	
			Verant.	D. LOCHER	1762 Givisiez			EASY B (B-SO71)		+	
			Kontr.								
Vers.	Modifikat.	Datum	Name	Norme	Original	Ersetzt:	Ersetzt von:	200008_s01a		Folio	12
										von	21S.

INTERN SCHALTSCHRANK
 EXTERN SCHALTSCHRANK

ANSCHLUSSDOSE WOERTZ



FLACHKABEL WOERTZ LNPE

13W2
 TD 2x1

SCHAKO
 EASY-B

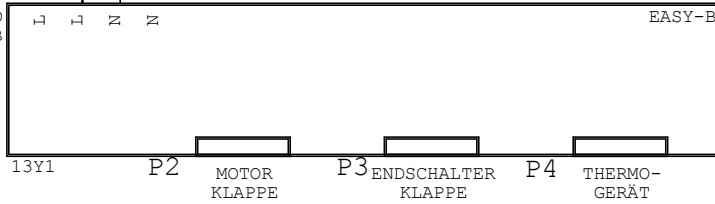

ADRESSE :

Nächste S. 14.9

		Datum	21.01.2015	SCHAKO (SUISSE) SA			ENTRAUCHUNGSKLAPPE EASY B (B-S071)		STROMANSCHLUSS SCHEMA		=
		Verant.	D. LOCHER	1762 Givisiez							+
		Kontr.									
Vers.	Modifikat.	Datum	Name	Norme	Original	Ersetzt:	Ersetzt von:	200008_s01a		Folio 13 von 21S.	

INTERN SCHALTSCHRANK
 EXTERN SCHALTSCHRANK

ANSCHLUSSDOSE WOERTZ



14W2
 TD 2x1

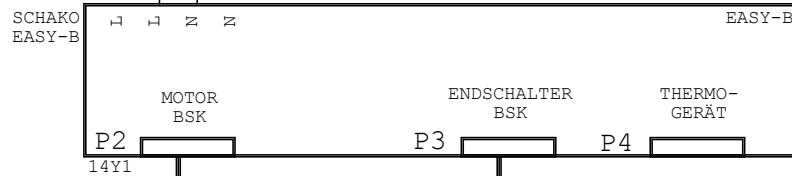

NUMERIRTER KABEL
 1 BIS 2

NUMERIRTER KABEL
 1 BIS 6

ADRESSE :

14W2.1
 TD 2x1

14W3
 TD 6x1

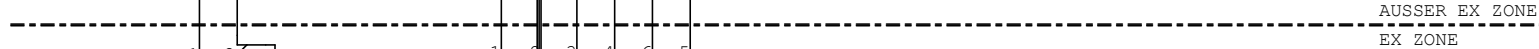

SCHISCHEK
 ExBox-BF



BSK
 SCHISCHEK



14Y1.1

ERDANSCHLUSS

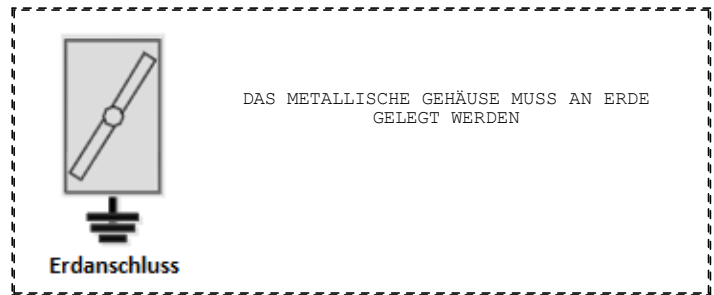

Nächste S. 15.9

		Datum	21.01.2015	SCHAKO (SUISSE) SA			BRANDSCHUTZKLAPPE EASY B	STROMANSCHLUSS SCHEMA	=	
		Verant.	D. LOCHER	1762 Givisiez			SCHISCHEK (B-S071)		+	
		Kontr.		Original		Ersetzt von:				Folio 14
Vers.	Modifikat.	Datum	Name	Norme	Original	Ersetzt von:		200008_s01a		von 21S.

INTERN SCHALTSCHRANK
 EXTERN SCHALTSCHRANK

ANSCHLUSSDOSE WOERTZ



15W2
 TD 2x1

SCHAKO
 EASY-V

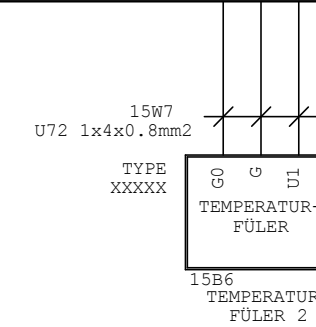
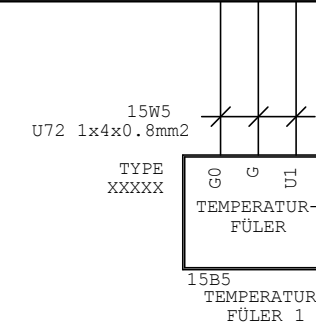
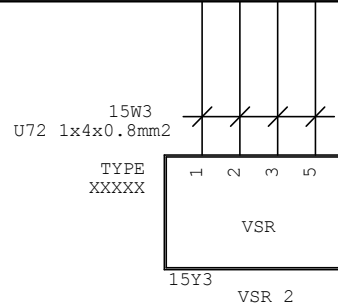
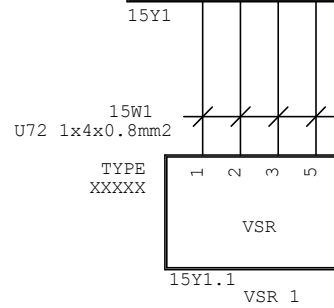
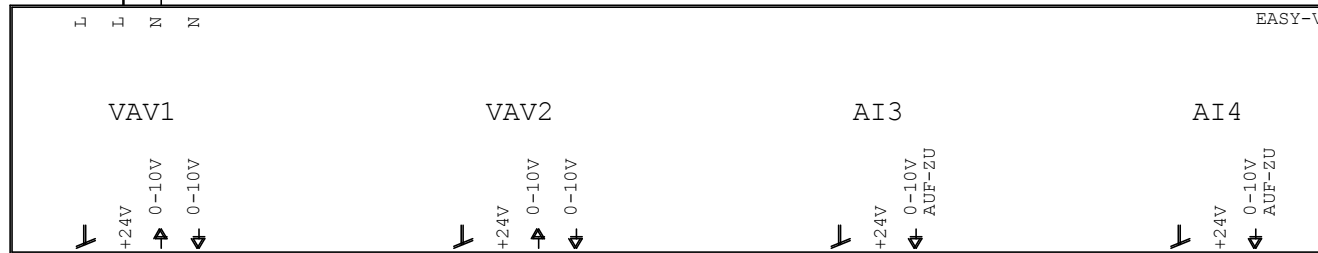

ADRESSE :

Nächste S. 16.9

Datum		21.01.2015		SCHAKO (SUISSE) SA 1762 Givisiez			VAV + TEMPERATURFÜHLER EASY-V (VAV-S072)		STROMANSCHLUSS SCHEMA		=	
Verant.		D. LOCHER					200008_s01a		Folio 15			
Kontr.							von 21S.					
Vers.	Modifikat.	Datum	Name	Norme	Original	Ersetzt:	Ersetzt von:					

INTERN SCHALTSCHRANK
 EXTERN SCHALTSCHRANK

ANSCHLUSSDOSE WOERTZ



EASY-V IRC

EASY-V IRC

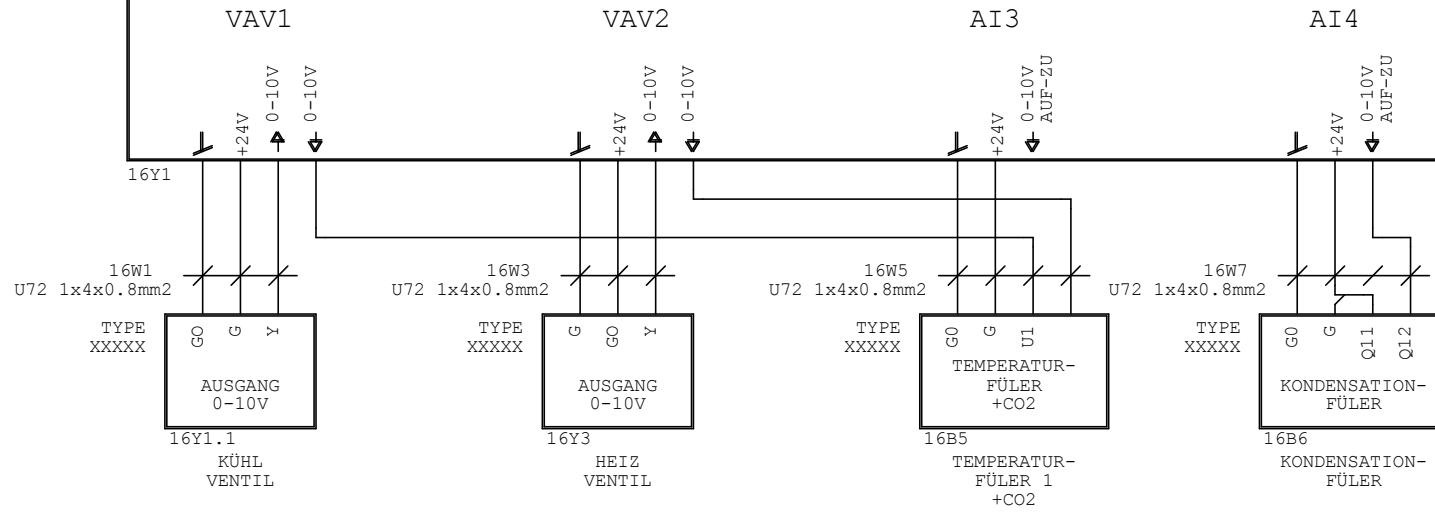

ADRESSE :

Nächste S. 17.9

Datum		21.01.2015		SCHAKO (SUISSE) SA		EASY-V IRC		STROMANSCHLUSS SCHEMA		=	
Verant.		D. LOCHER		1762 Givisiez		KLIMA-LUFT		200008_s01a		Folio 16	
Kontr.				Original		Ersetzt von:				von 21S.	
Vers.		Modifikat.		Datum		Name		Norme			

INTERN SCHALTSCHRANK
 EXTERN SCHALTSCHRANK

ANSCHLUSSDOSE WOERTZ



17W2
 TD 2x1

SCHAKO
 EASY-B
 230V

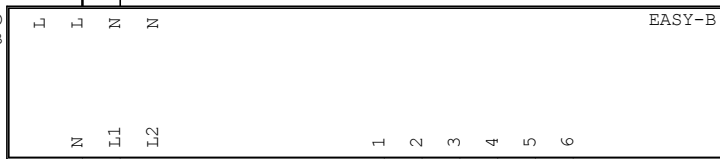

17Y1

17W2.1
 TD 2x1

BSK

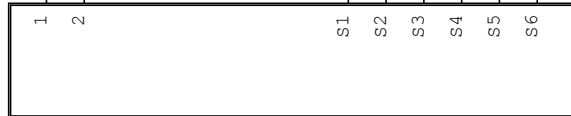

17Y1.1

17W3
 TD 6x1

ADRESSE :

Nächste S. 18.9

			Datum	21.01.2015	SCHAKO (SUISSE) SA 1762 Givisiez		BRANDSCHUTZKLAPPE EASY B 230 (B-S073)	STROMANSCHLUSS SCHEMA	=	
			Verant.	D. LOCHER					+	
			Kontr.							
Vers.	Modifikat.	Datum	Name	Norme	Original	Ersetzt:	Ersetzt von:	200008_s01a	Folio 17	von 21S.

INTERN SCHALTSCHRANK
 EXTERN SCHALTSCHRANK

ANSCHLUSSDOSE WOERTZ



18W2
 TD 2x1

SCHAKO
 EASY-B
 230V

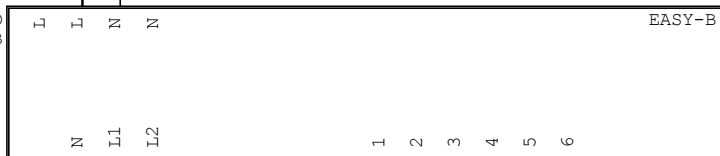

18Y1

18W2.1
 TD 3x1

KLAPPE

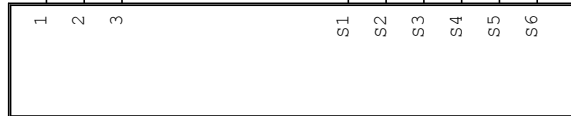

18Y1.1

18W3
 TD 6x1

ADRESSE :

Nächste S. 19.9

Datum	21.01.2015	SCHAKO (SUISSE) SA 1762 Givisiez		ENTRAUCHUNGSKLAPPE EASY B 230 (B-S073)	STROMANSCHLUSS SCHEMA	=	Folio 18		
Verant.	D. LOCHER							200008_s01a	von 21S.
Kontr.									
Vers.	Modifikat.	Datum	Name	Norme	Original	Ersetzt:	Ersetzt von:		

A

INTERN SCHALTSCHRANK
 EXTERN SCHALTSCHRANK

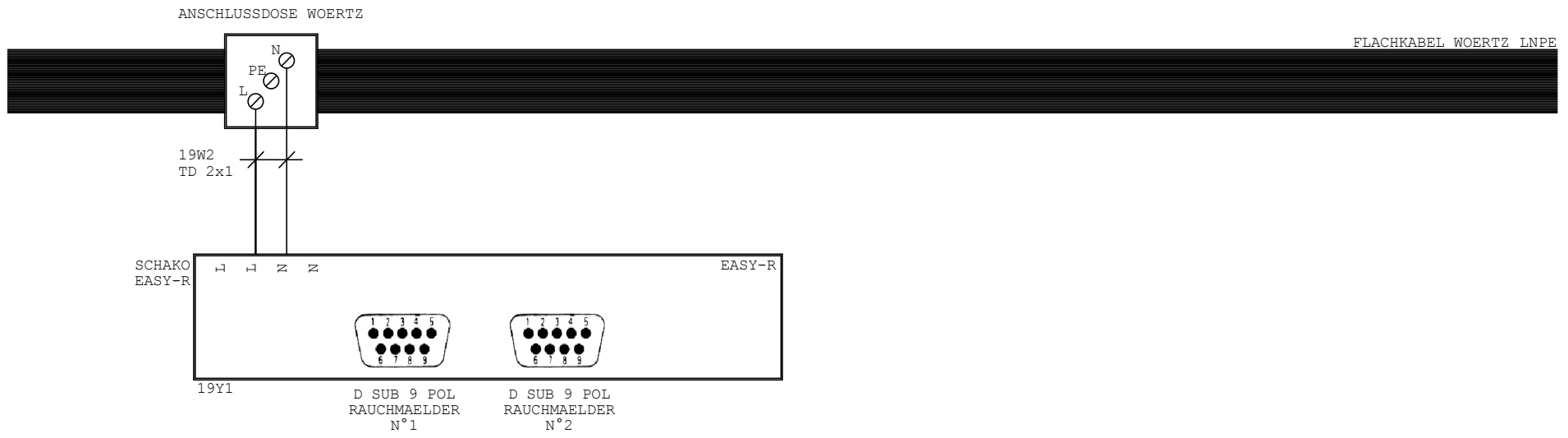

ADRESSE :

Nächste S. 20.9

F

			Datum	21.01.2015	SCHAKO (SUISSE) SA			EASY-R (R-S075)	STROMANSCHLUSS SCHEMA	=	
			Verant.	D. LOCHER	1762 Givisiez					+	
			Kontr.								
Vers.	Modifikat.	Datum	Name	Norme	Original	Ersetzt:	Ersetzt von:		200008_s01a		Folio 19 von 21S.

F

INTERN SCHALTSCHRANK
 EXTERN SCHALTSCHRANK

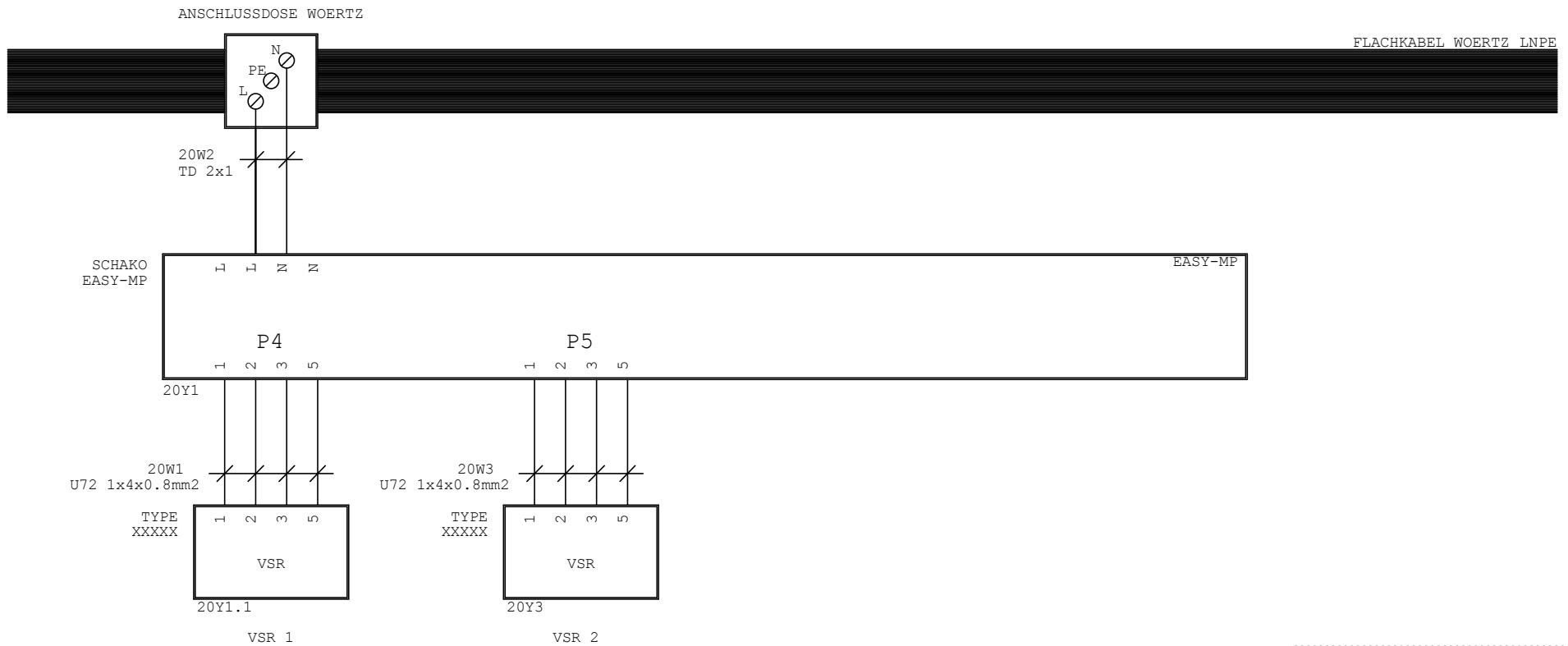

ADRESSE :

Nächste S. 21.9

			Datum	21.01.2015	SCHAKO (SUISSE) SA		VAV EASY-MP (MP-S076)	STROMANSCHLUSS SCHEMA	=	
		Verant.	D. LOCHER						+	
		Kontr.		1762 Givisiez						
Vers.	Modifikat.	Datum	Name	Norme	Original	Ersetzt:	Ersetzt von:	200008_s01a	Folio 20	von 21S.

