

KUNDE : INTEGRATOR

VERSION 2

PROJEKT : EASYBUS



BÜRO : SCHAKO SUISSE SA  
RUE JEAN PROUVE 28  
1762 GIVISIEZ

TEL : 026 460 88 00 FAX: 026 460 88 05

DIESES SCHEMA IST GEISTIGES  
EIGENTUM VON SCHAKO

ÄNDERUNGEN ODER ANPASSUNGEN  
SIND OHNE UNSERE  
AUSDRÜCKLICHE ZUSTIMMUNG  
NICHT ERLAUBT

DAS EMPFOHLENE MATERIAL  
MUSS GEMÄSS VORSCHRIFT  
DES HERSTELLERS  
MONTIERT WERDEN

DIE AUFGEFÜHRTEN KONTAKTE  
SIND OHNE SPANNUNG  
ANGEGEBEN

DIEMENSIONIEREN SIE DAS  
ANSCHLUSSKABEL LAUT  
ANGABEN DES  
ENERGIVERSORGERERS

INSTALLATION:

AUTOMAT : SIEMENS POL 638.70

NETZWERKBRÜCKE ZEHNDER  
1 MASTER 2 MONOBLOCS

| REV | NOM       | DATE       | REV | NOM | DATE |
|-----|-----------|------------|-----|-----|------|
| 1   | LOCHER D. | 08.01.2014 |     |     |      |
|     |           |            |     |     |      |
|     |           |            |     |     |      |
|     |           |            |     |     |      |
|     |           |            |     |     |      |
|     |           |            |     |     |      |

Nächste S. 20.9

|       |            |         |            |                                     |          |              |                                 |             |                       |
|-------|------------|---------|------------|-------------------------------------|----------|--------------|---------------------------------|-------------|-----------------------|
|       |            | Datum   | 03.07.2014 | SCHAKO (SUISSE) SA<br>1762 Givisiez |          | VORSATZBLATT | NETZWERK. ZEHNDER 1 MAS. 2 MON. | =           |                       |
|       |            | Verant. |            |                                     |          |              |                                 | +           |                       |
|       |            | Kontr.  |            |                                     |          |              |                                 |             |                       |
| Vers. | Modifikat. | Datum   | Name       | Norme                               | Original | Ersetzt:     | Ersetzt von:                    | 200008_s041 | Folio 0<br>von 126 S. |



# AUTOMAT

Nächste S. 22.9

|       |            |       |         |            |                    |          |   |         |                                 |          |           |
|-------|------------|-------|---------|------------|--------------------|----------|---|---------|---------------------------------|----------|-----------|
|       |            |       | Datum   | 03.07.2014 | SCHAKO (SUISSE) SA |          |  | AUTOMAT | NETZWERK. ZEHNDER 1 MAS. 2 MON. | =        |           |
|       |            |       | Verant. |            | 1762 Givisiez      |          |   |         |                                 | +        |           |
|       |            |       | Kontr.  |            |                    |          |   |         |                                 |          |           |
| Vers. | Modifikat. | Datum | Name    | Norme      | Original           | Ersetzt: | Ersetzt von:  |         | 200008_s041                     | Folio 20 | von 126S. |

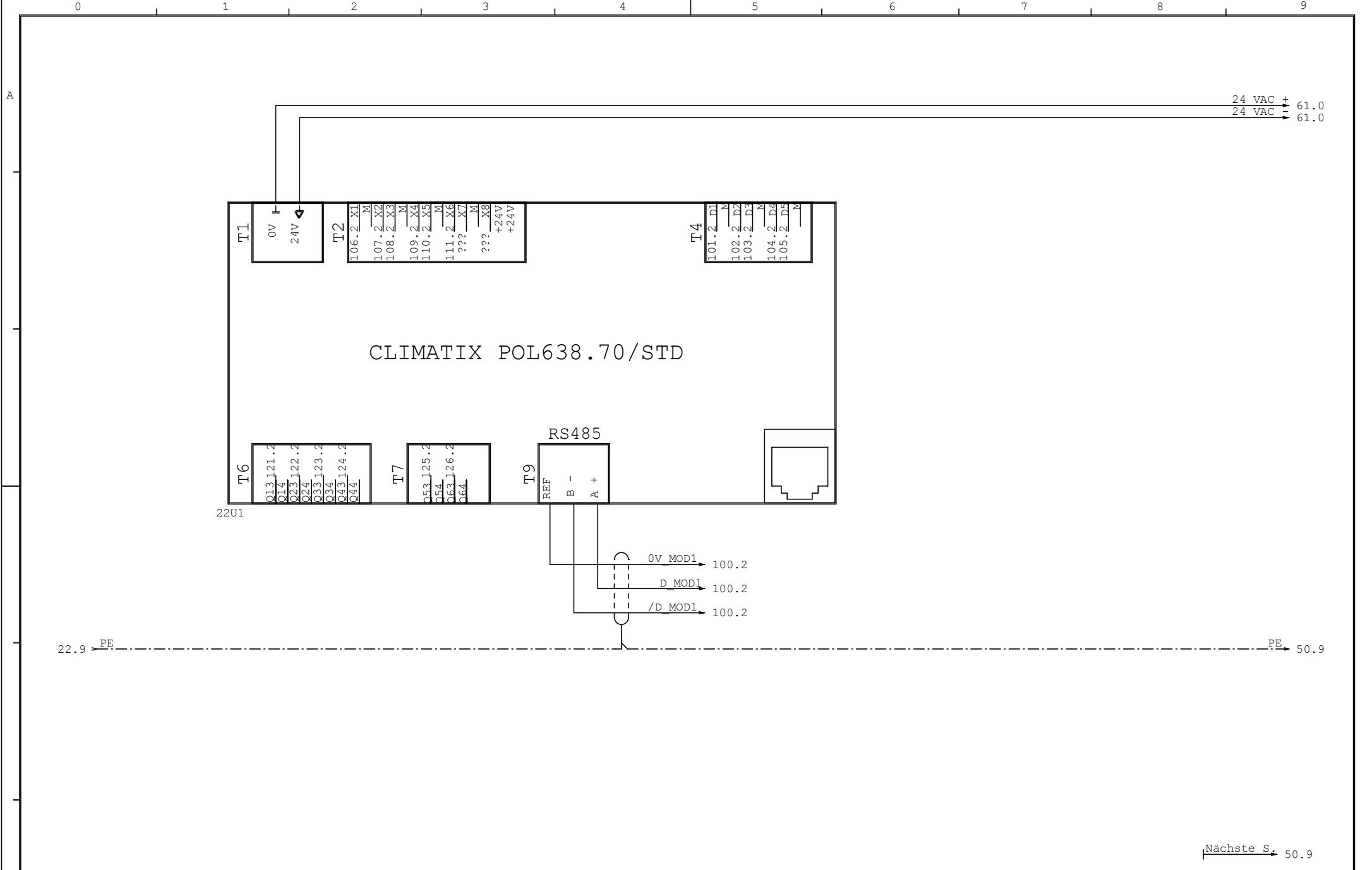

CLIMATIX POL638.70/STD

Nächste S. 50.9

|       |            |         |            |                    |          |   |                |                                 |           |          |
|-------|------------|---------|------------|--------------------|----------|---|----------------|---------------------------------|-----------|----------|
|       |            | Datum   | 03.07.2014 | SCHAKO (SUISSE) SA |          |  | NETZWERKBRÜCKE | NETZWERK. ZEHNDER 1 MAS. 2 MON. | =         |          |
|       |            | Verant. |            | 1762 Givisiez      |          |   |                |                                 | +         |          |
|       |            | Kontr.  |            |                    |          |   |                |                                 |           | Folio 22 |
| Vers. | Modifikat. | Datum   | Name       | Norme              | Original | Ersetztzt:  | Ersetzt von:   | 200008_s041                     | von 126S. |          |



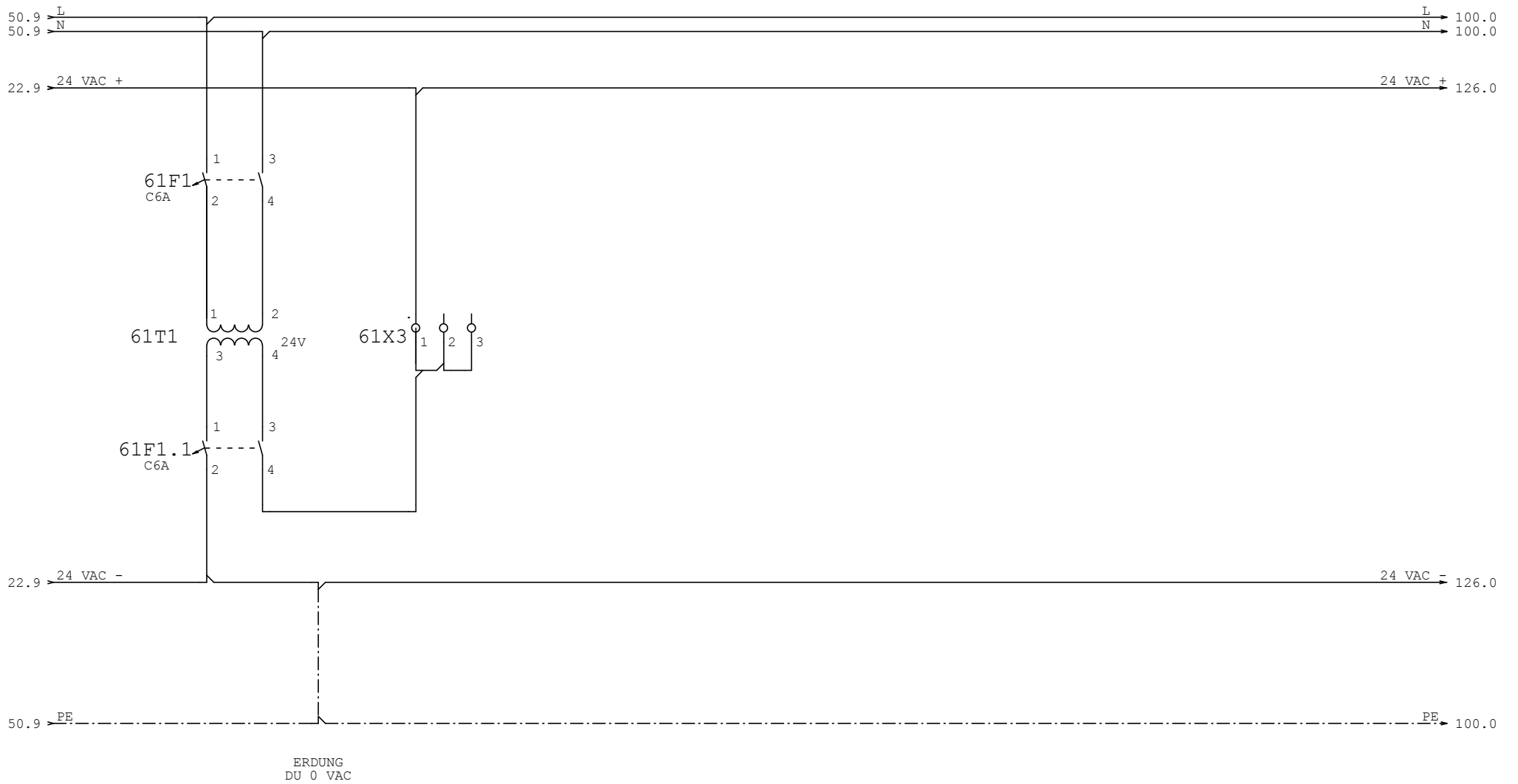

Nächste S. 99.9

|       |            |       |         |            |                                     |   |                        |                                 |                       |   |
|-------|------------|-------|---------|------------|-------------------------------------|---|------------------------|---------------------------------|-----------------------|---|
|       |            |       | Datum   | 03.07.2014 | SCHAKO (SUISSE) SA<br>1762 Givisiez |  | STROMVERSORGUNG 24 VAC | NETZWERK. ZEHNDER 1 MAS. 2 MON. | =                     |   |
|       |            |       | Verant. |            |                                     |   |                        |                                 |                       | + |
|       |            |       | Kontr.  |            |                                     |   |                        |                                 |                       |   |
| Vers. | Modifikat. | Datum | Name    | Norme      | Original                            | Ersetzt:  | Ersetzt von:           | 200008_s041                     | Folio 61<br>von 126S. |   |

# EASYBUS BSK

Nächste S. 100.9

|       |            |       |         |            |                    |          |   |             |                                 |  |                       |   |
|-------|------------|-------|---------|------------|--------------------|----------|---|-------------|---------------------------------|--|-----------------------|---|
|       |            |       | Datum   | 03.07.2014 | SCHAKO (SUISSE) SA |          |  | EASYBUS BSK | NETZWERK. ZEHNDER 1 MAS. 2 MON. |  | =                     |   |
|       |            |       | Verant. |            | 1762 Givisiez      |          |   |             |                                 |  |                       | + |
|       |            |       | Kontr.  |            |                    |          |   |             |                                 |  |                       |   |
| Vers. | Modifikat. | Datum | Name    | Norme      | Original           | Ersetzt: | Ersetzt von:  |             | 200008_s041                     |  | Folio 99<br>von 126S. |   |

61.9 L → 100.0  
 61.9 N → 100.0  
 61.9 PE → 101.0

**!**  
 WENN MEHRERE MASTER DAN  
 KANNÄLE AM MASTER UND AN  
 SEINEM EASYBUS NETZ WECHSELN

BEISPIEL HIER : FREQ = 1 CANAL = 1

MAXIMAL TEILNEHMER = 128  
 MAXIMALE BUSLÄNGE = 1000M

ALLE TOPOLOGIE ZUGELASSEN

DER FILTER MUSS MINIMAL > 50CM  
 EINEM FREQUENZVARIATOR  
 INSTALLIERT WERDEN

RS-485 / 232  
 MODBUS RTU  
 BAUDRATE=19200  
 BITS=8-E-2  
 ADRESSE=1

AM AUTOMAT

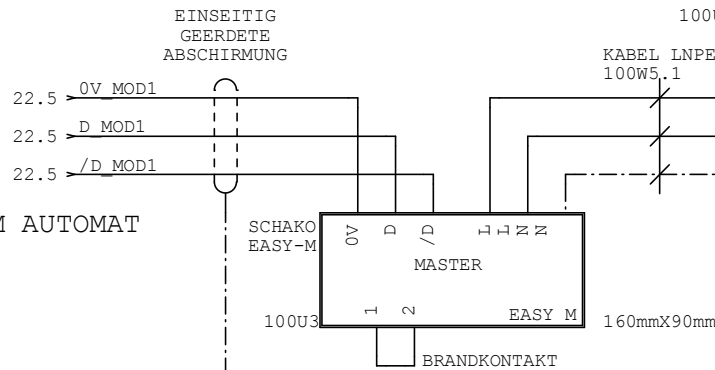

61.9 PE → 101.0

KABEL DIREKT AM FILTER  
 ANSCHLIESSEN. ZWISCHEN DIE  
 ANSCHLUSSDOSE UND DEN FILTER  
 MÜSSEN KEINE KLEMMEN  
 ANGESCHLOSSEN WERDEN.  
 MINIMUM 3X2.5MM2

INTERN SCHALTSCHRANK  
 EXTERN SCHALTSCHRANK

**!**  
 DIMENSIONIEREN SIE DAS  
 ANSCHLUSSKABEL LAUT  
 ANGABEN DES  
 ENERGIVERSORGERS

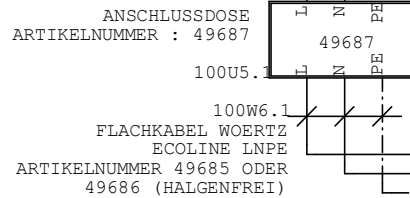

L EASY → 100a.0  
 N EASY → 100a.0  
 PE EE → 100a.0

Nächste S. → 100a.9

|       |            |       |      |         |            |                    |              |  |             |                                 |  |           |           |
|-------|------------|-------|------|---------|------------|--------------------|--------------|--|-------------|---------------------------------|--|-----------|-----------|
|       |            |       |      | Datum   | 03.07.2014 |                    |              |  | EASY MASTER | NETZWERK. ZEHNDER 1 MAS. 2 MON. |  | =         |           |
|       |            |       |      | Verant. |            | SCHAKO (SUISSE) SA |              |  |             |                                 |  |           | +         |
|       |            |       |      | Kontr.  |            | 1762 Givisiez      |              |  |             |                                 |  |           | Folio 100 |
| Vers. | Modifikat. | Datum | Name | Norme   | Original   | Ersetzt:           | Ersetzt von: |  |             | 200008_s041                     |  | von 126S. |           |



INTERN SCHALTSCHRANK  
 EXTERN SCHALTSCHRANK

ANSCHLUSSDOSE 3x2.5mm<sup>2</sup>  
 ARTIKELNUMMER : 49695

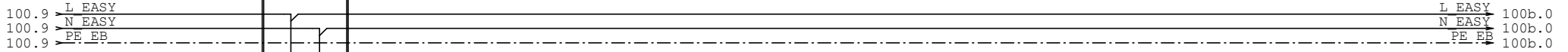

100aW2  
 TD 2x1

SCHAKO  
 EASY-B

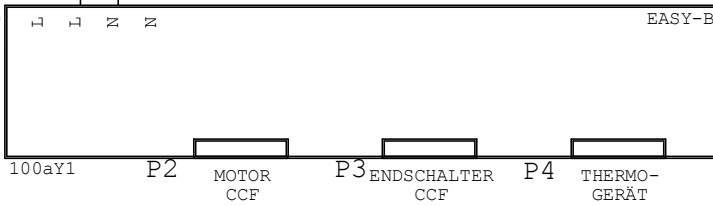

BEISPIEL HIER : FREQ = 1 CANAL = 1

ADRESSE : .....

Nächste S. 100b.9

|       |            |       |         |            |                                     |   |              |                                 |            |            |  |
|-------|------------|-------|---------|------------|-------------------------------------|---|--------------|---------------------------------|------------|------------|--|
|       |            |       | Datum   | 03.07.2014 | SCHAKO (SUISSE) SA<br>1762 Givisiez |  | EASY-B       | NETZWERK. ZEHNDER 1 MAS. 2 MON. | =          |            |  |
|       |            |       | Verant. |            |                                     |   |              |                                 |            | +          |  |
|       |            |       | Kontr.  |            |                                     |   |              |                                 |            |            |  |
| Vers. | Modifikat. | Datum | Name    | Norme      | Original                            | Ersetzt:  | Ersetzt von: | 200008_s041                     | Folio 100a | von 126 S. |  |

INTERN SCHALTSCHRANK  
 EXTERN SCHALTSCHRANK

ANSCHLUSSDOSE 3x2.5mm<sup>2</sup>  
 ARTIKELNUMMER : 49695

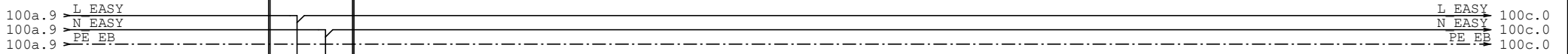

100bW2  
 TD 2x1

SCHAKO  
 EASY-B  
 230V

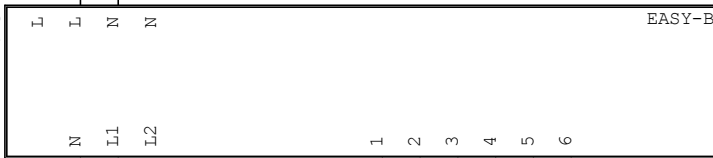

100by1

100bW2  
 TD 2x1

CCF

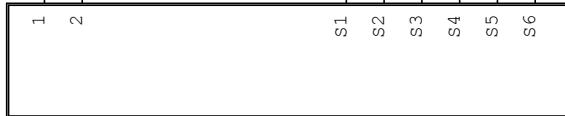

100by1.1

100bW3  
 TD 6x1

BEISPIEL HIER : FREQ = 1 CANAL = 1

ADRESSE : .....

Nächste S. 100c.9

|         |            |                                     |   |             |                                 |          |                          |             |
|---------|------------|-------------------------------------|---|-------------|---------------------------------|----------|--------------------------|-------------|
| Datum   | 03.07.2014 | SCHAKO (SUISSE) SA<br>1762 Givisiez |  | EASY-B 230V | NETZWERK. ZEHNDER 1 MAS. 2 MON. | =        | Folio 100b<br>von 126 S. |             |
| Verant. |            |                                     |   |             |                                 |          |                          | 200008_s041 |
| Kontr.  |            |                                     |   |             |                                 |          |                          |             |
| Vers.   | Modifikat. | Datum                               | Name  | Norme       | Original                        | Ersetzt: | Ersetzt von:             |             |

INTERN SCHALTSCHRANK  
 EXTERN SCHALTSCHRANK

ANSCHLUSSDOSE 3x2.5mm2  
 ARTIKELNUMMER : 49695

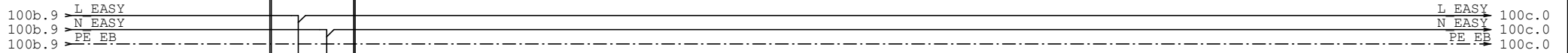

100cW2  
 TD 2x1

SCHAKO  
 EASY-R

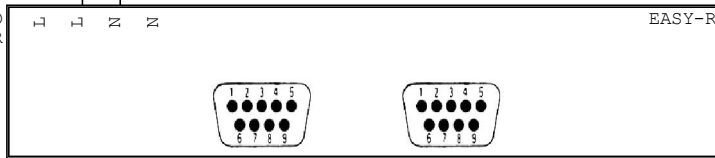

BEISPIEL HIER : FREQ = 1 CANAL = 1

ADRESSE : .....

Nächste S. 101.9

|       |            |         |            |                                     |   |          |                                 |             |                          |   |  |
|-------|------------|---------|------------|-------------------------------------|---|----------|---------------------------------|-------------|--------------------------|---|--|
|       |            | Datum   | 03.07.2014 | SCHAKO (SUISSE) SA<br>1762 Givisiez |  | EASY-R   | NETZWERK. ZEHNDER 1 MAS. 2 MON. | =           |                          |   |  |
|       |            | Verant. |            |                                     |   |          |                                 |             |                          | + |  |
|       |            | Kontr.  |            |                                     |   |          |                                 |             |                          |   |  |
| Vers. | Modifikat. | Datum   | Name       | Norme                               | Original  | Ersetzt: | Ersetzt von:                    | 200008_s041 | Folio 100c<br>von 126 S. |   |  |

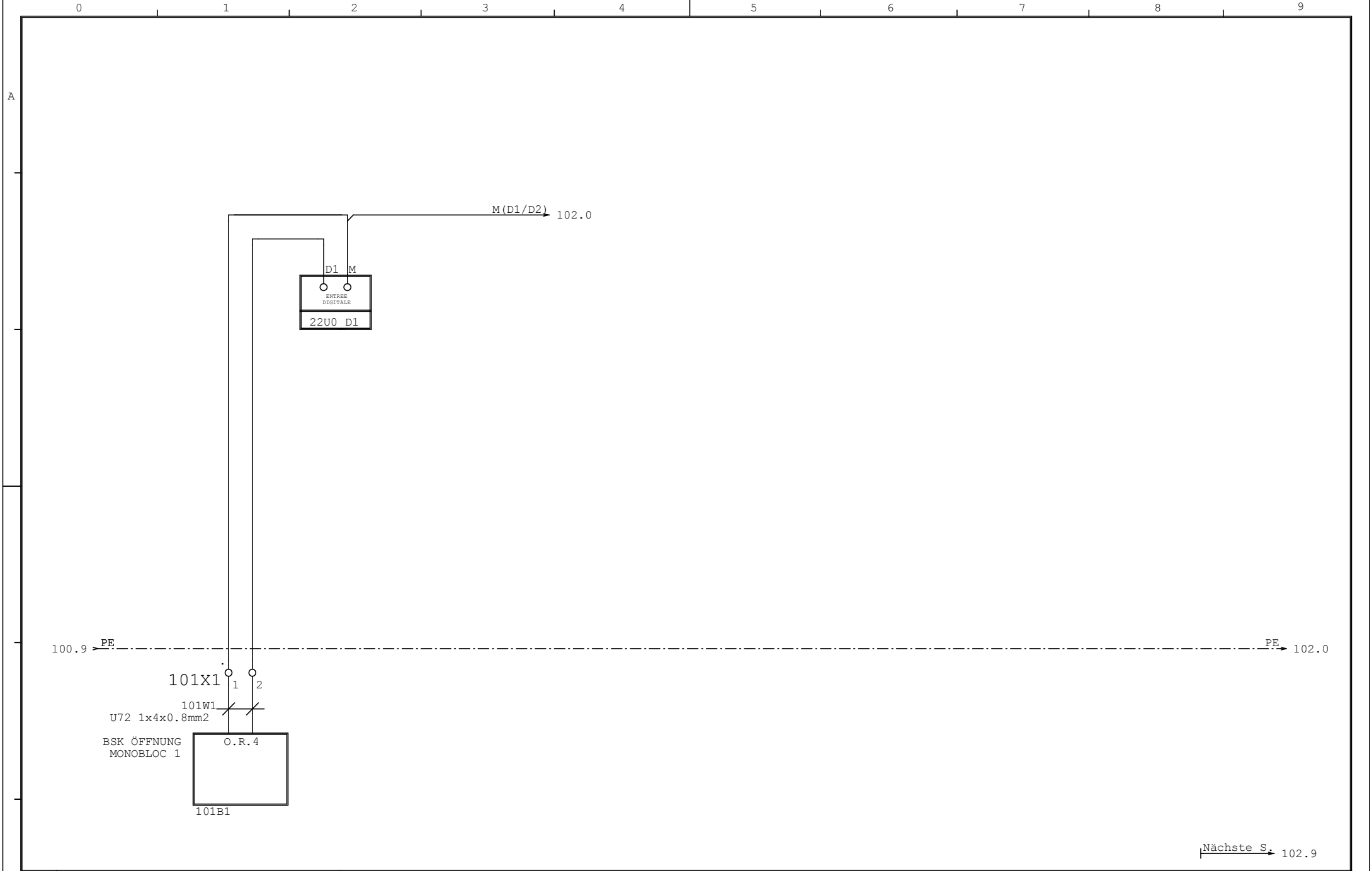

Nächste S. 102.9

|       |            |       |         |            |                    |   |                        |                                 |             |                     |
|-------|------------|-------|---------|------------|--------------------|---|------------------------|---------------------------------|-------------|---------------------|
|       |            |       | Datum   | 03.07.2014 | SCHAKO (SUISSE) SA |  | BSK ÖFFNUNG MONOBLOC 1 | NETZWERK. ZEHNDER 1 MAS. 2 MON. | =           |                     |
|       |            |       | Verant. |            | 1762 Givisiez      |   |                        |                                 | +           |                     |
|       |            |       | Kontr.  |            |                    |   |                        |                                 |             |                     |
| Vers. | Modifikat. | Datum | Name    | Norme      | Original           | Ersetzt:  | Ersetzt von:           |                                 | 200008_s041 | Folio 101 von 126S. |

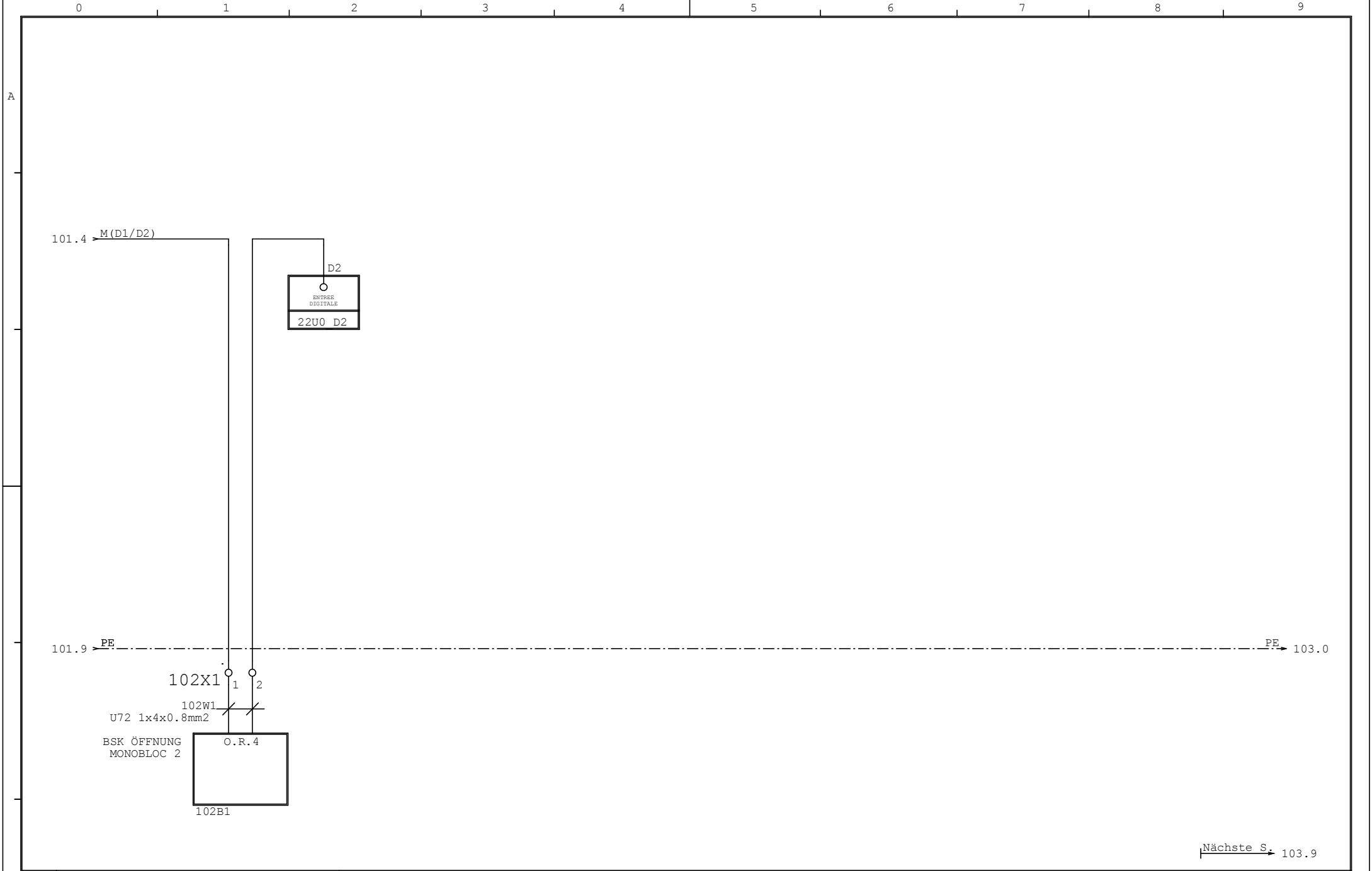

|       |            |       |         |               |                    |   |                           |                                 |           |           |
|-------|------------|-------|---------|---------------|--------------------|---|---------------------------|---------------------------------|-----------|-----------|
|       |            |       | Datum   | 03.07.2014    | SCHAKO (SUISSE) SA |  | BSK ÖFFNUNG<br>MONOBLOC 2 | NETZWERK. ZEHNDER 1 MAS. 2 MON. | =         |           |
|       |            |       | Verant. |               |                    |   |                           |                                 | +         |           |
|       |            |       | Kontr.  | 1762 Givisiez |                    |   |                           |                                 |           |           |
| Vers. | Modifikat. | Datum | Name    | Norme         | Original           | Ersetzt:  | Ersetzt von:              | 200008_s041                     | Folio 102 | von 126S. |

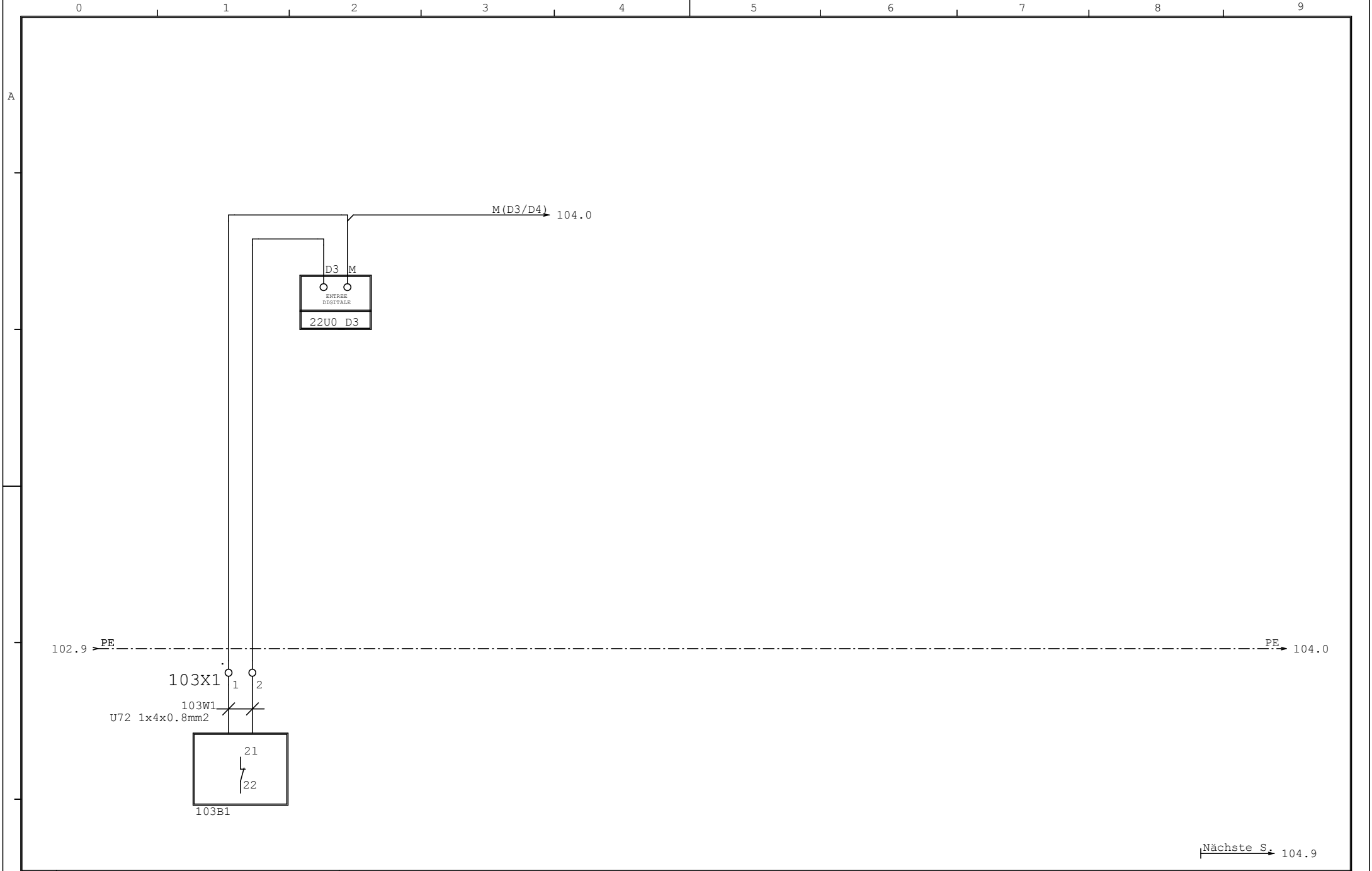

Nächste S. 104.9

|       |            |       |         |            |                                     |   |                            |                                 |             |                        |  |
|-------|------------|-------|---------|------------|-------------------------------------|---|----------------------------|---------------------------------|-------------|------------------------|--|
|       |            |       | Datum   | 03.07.2014 | SCHAKO (SUISSE) SA<br>1762 Givisiez |  | DIGITALEINGANG 3 (RESERVE) | NETZWERK. ZEHNDER 1 MAS. 2 MON. | =           |                        |  |
|       |            |       | Verant. |            |                                     |   |                            |                                 |             | +                      |  |
|       |            |       | Kontr.  |            |                                     |   |                            |                                 |             |                        |  |
| Vers. | Modifikat. | Datum | Name    | Norme      | Original                            | Ersetzt:  | Ersetzt von:               |                                 | 200008_s041 | Folio 103<br>von 126S. |  |

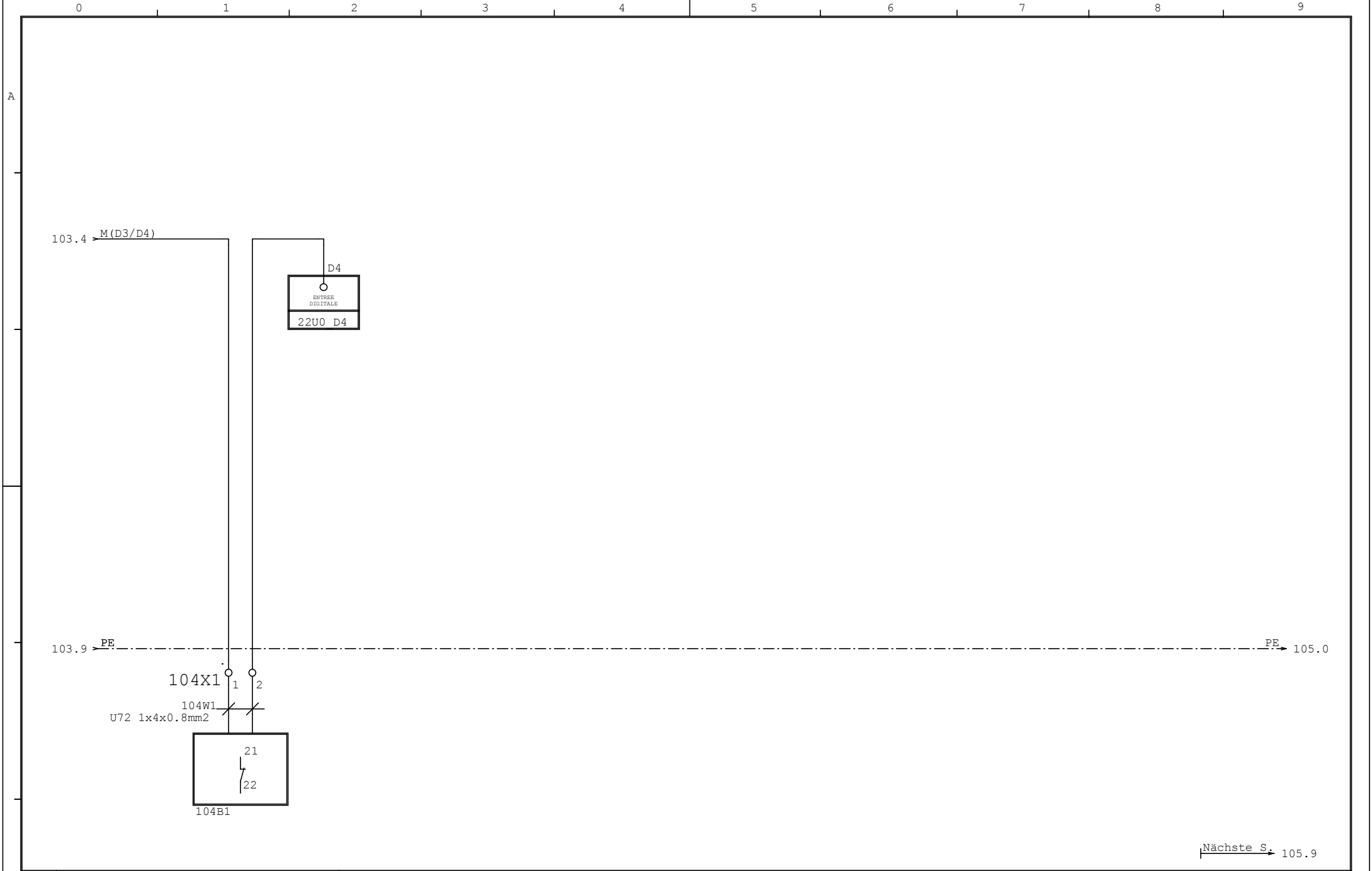

Nächste S. 105.9

|       |            |       |         |            |                    |   |                            |                                 |               |                        |  |  |
|-------|------------|-------|---------|------------|--------------------|---|----------------------------|---------------------------------|---------------|------------------------|--|--|
|       |            |       | Datum   | 03.07.2014 | SCHAKO (SUISSE) SA |  | DIGITALEINGANG 4 (RESERVE) | NETZWERK. ZEHNDER 1 MAS. 2 MON. | =             |                        |  |  |
|       |            |       | Verant. |            |                    |   |                            |                                 |               |                        |  |  |
|       |            |       | Kontr.  |            |                    |   |                            |                                 | 1762 Givisiez |                        |  |  |
| Vers. | Modifikat. | Datum | Name    | Norme      | Original           | Ersetzt:  | Ersetzt von:               |                                 | 200008_s041   | Folio 104<br>von 126S. |  |  |

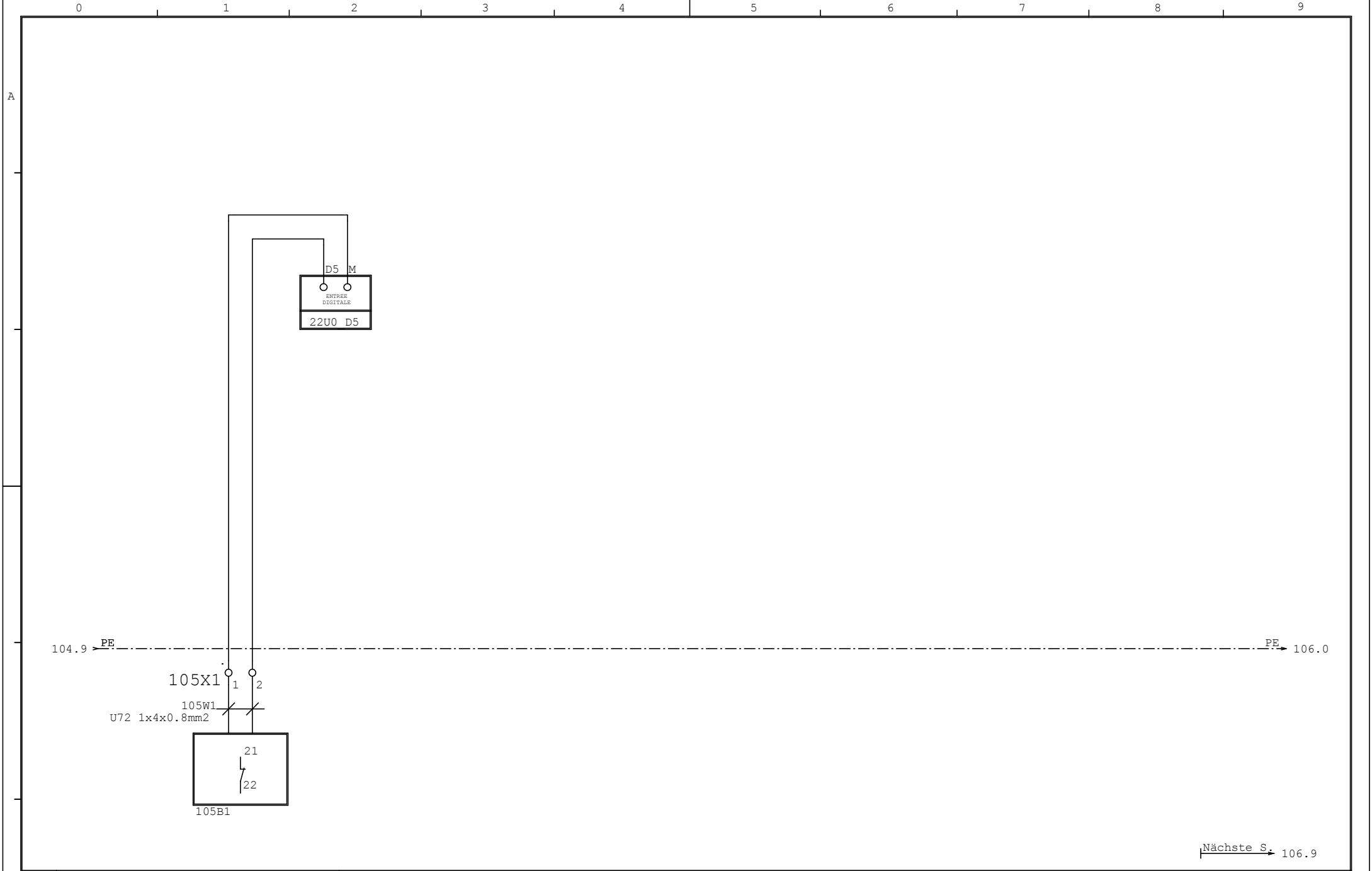

|       |            |       |      |         |            |                    |              |   |                            |             |                                 |           |   |
|-------|------------|-------|------|---------|------------|--------------------|--------------|---|----------------------------|-------------|---------------------------------|-----------|---|
|       |            |       |      | Datum   | 03.07.2014 | SCHAKO (SUISSE) SA |              |  | DIGITALEINGANG 5 (RESERVE) |             | NETZWERK. ZEHNDER 1 MAS. 2 MON. |           | = |
|       |            |       |      | Verant. |            | 1762 Givisiez      |              |   |                            |             |                                 |           | + |
|       |            |       |      | Kontr.  |            |                    |              |   |                            |             |                                 |           |   |
| Vers. | Modifikat. | Datum | Name | Norme   | Original   | Ersetzt:           | Ersetzt von: |   |                            | 200008_s041 |                                 | Folio 105 |   |
|       |            |       |      |         |            |                    |              |   |                            |             |                                 | von 126S. |   |



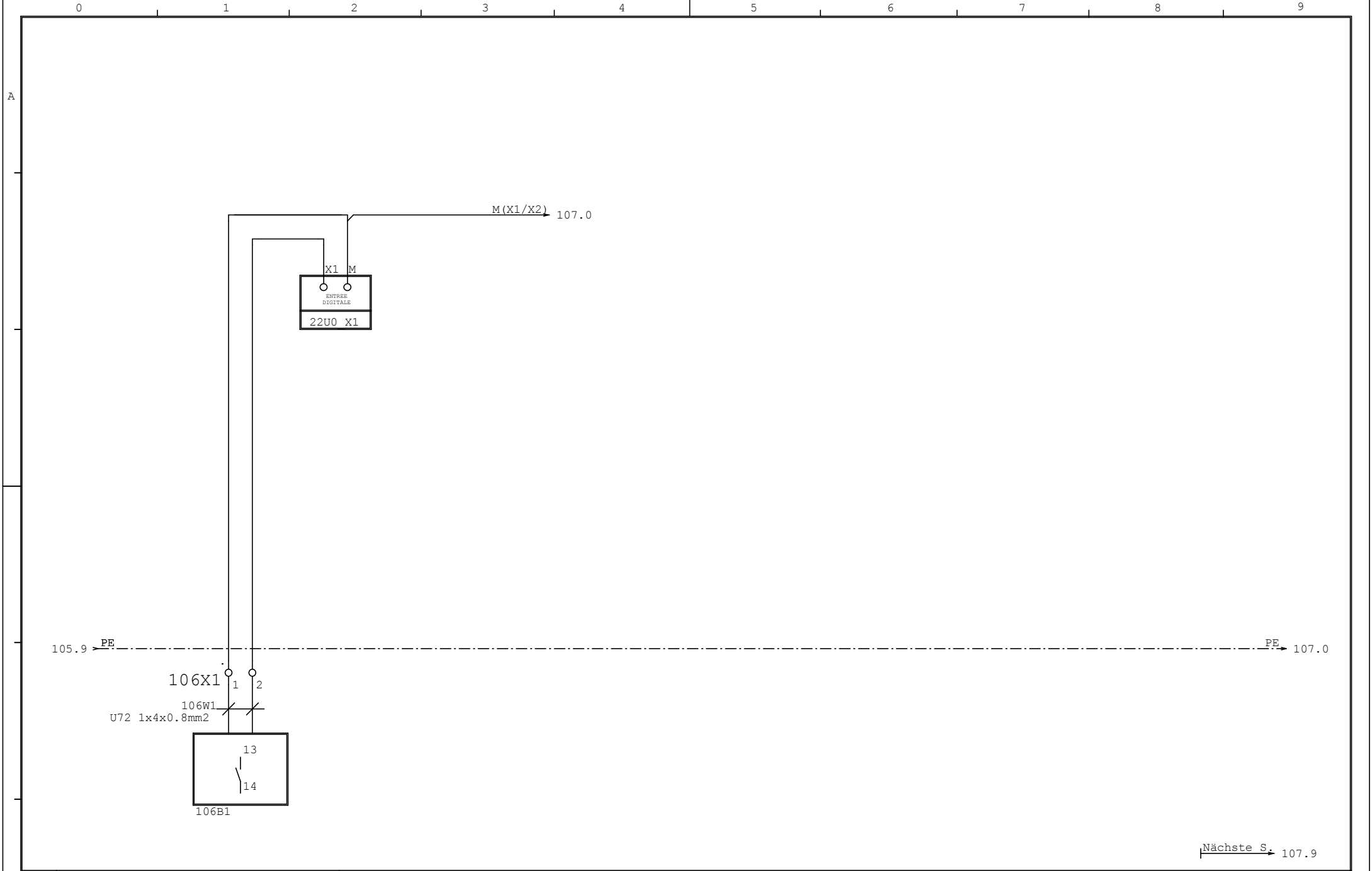

Nächste S. 107.9

|       |            |       |         |            |                    |   |                            |                                 |               |                        |  |  |  |
|-------|------------|-------|---------|------------|--------------------|---|----------------------------|---------------------------------|---------------|------------------------|--|--|--|
|       |            |       | Datum   | 03.07.2014 | SCHAKO (SUISSE) SA |  | DIGITALEINGANG 6 (RESERVE) | NETZWERK. ZEHNDER 1 MAS. 2 MON. | =             |                        |  |  |  |
|       |            |       | Verant. |            |                    |   |                            |                                 |               |                        |  |  |  |
|       |            |       | Kontr.  |            |                    |   |                            |                                 | 1762 Givisiez |                        |  |  |  |
| Vers. | Modifikat. | Datum | Name    | Norme      | Original           | Ersetzt:  | Ersetzt von:               |                                 | 200008_s041   | Folio 106<br>von 126S. |  |  |  |

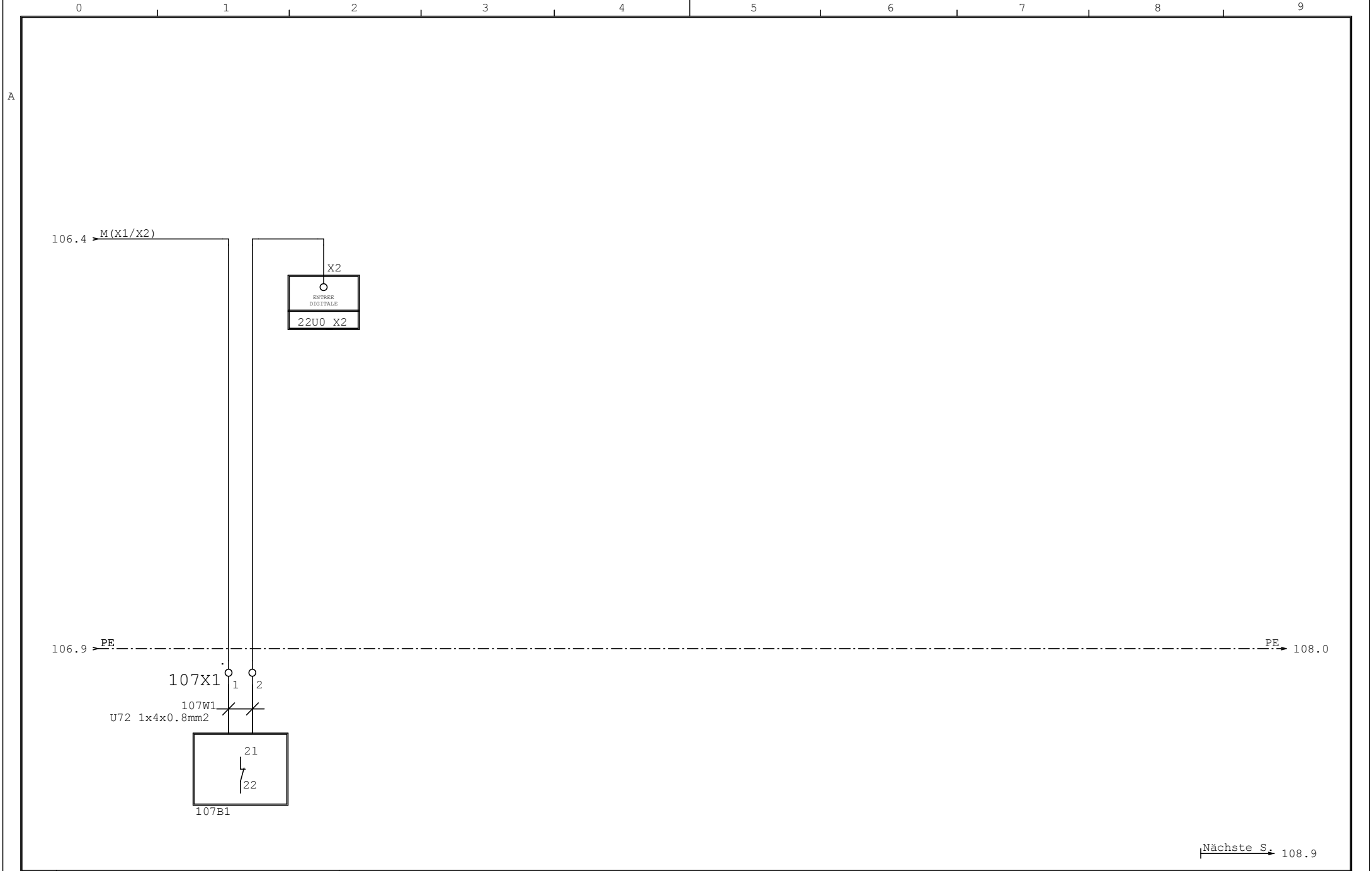

Nächste S. 108.9

|       |            |       |         |            |                    |   |                            |                                 |           |           |
|-------|------------|-------|---------|------------|--------------------|---|----------------------------|---------------------------------|-----------|-----------|
|       |            |       | Datum   | 03.07.2014 | SCHAKO (SUISSE) SA |  | DIGITALEINGANG 7 (RESERVE) | NETZWERK. ZEHNDER 1 MAS. 2 MON. | =         |           |
|       |            |       | Verant. |            | 1762 Givisiez      |   |                            |                                 | +         |           |
|       |            |       | Kontr.  |            |                    |   |                            |                                 |           |           |
| Vers. | Modifikat. | Datum | Name    | Norme      | Original           | Ersetzt:  | Ersetzt von:               | 200008_s041                     | Folio 107 | von 126S. |

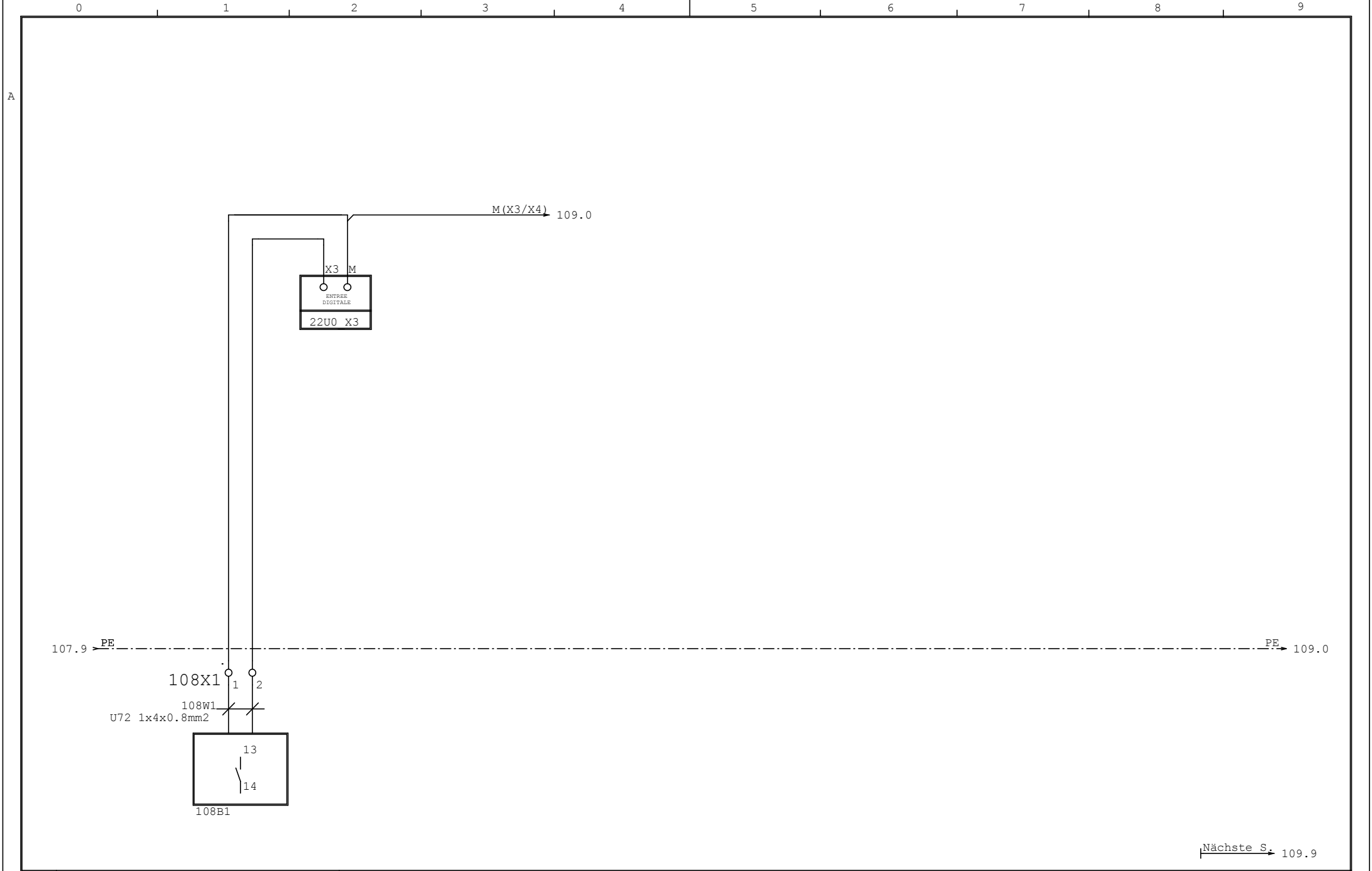

Nächste S. 109.9

|       |            |       |         |            |                                     |   |                            |                                 |             |                        |  |  |
|-------|------------|-------|---------|------------|-------------------------------------|---|----------------------------|---------------------------------|-------------|------------------------|--|--|
|       |            |       | Datum   | 03.07.2014 | SCHAKO (SUISSE) SA<br>1762 Givisiez |  | DIGITALEINGANG 8 (RESERVE) | NETZWERK. ZEHNDER 1 MAS. 2 MON. | =           |                        |  |  |
|       |            |       | Verant. |            |                                     |   |                            |                                 |             |                        |  |  |
|       |            |       | Kontr.  |            |                                     |   |                            |                                 |             |                        |  |  |
| Vers. | Modifikat. | Datum | Name    | Norme      | Original                            | Ersetzt:  | Ersetzt von:               |                                 | 200008_s041 | Folio 108<br>von 126S. |  |  |

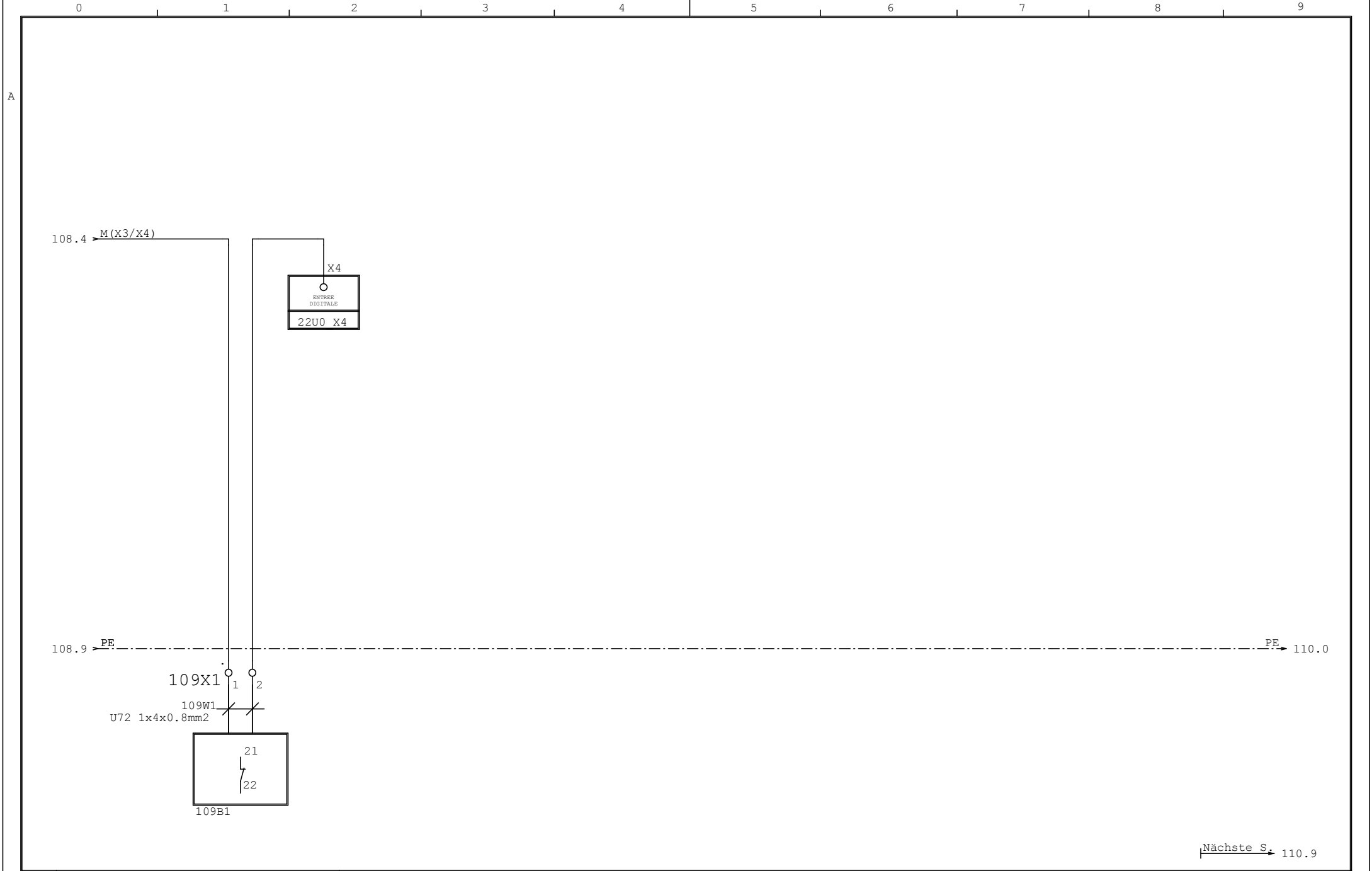

Nächste S. 110.9

|       |            |       |         |            |                    |   |                            |                                 |           |           |
|-------|------------|-------|---------|------------|--------------------|---|----------------------------|---------------------------------|-----------|-----------|
|       |            |       | Datum   | 03.07.2014 | SCHAKO (SUISSE) SA |  | DIGITALEINGANG 9 (RESERVE) | NETZWERK. ZEHNDER 1 MAS. 2 MON. | =         |           |
|       |            |       | Verant. |            | 1762 Givisiez      |   |                            |                                 | +         |           |
|       |            |       | Kontr.  |            |                    |   |                            |                                 |           |           |
| Vers. | Modifikat. | Datum | Name    | Norme      | Original           | Ersetzt:  | Ersetzt von:               | 200008_s041                     | Folio 109 | von 126S. |

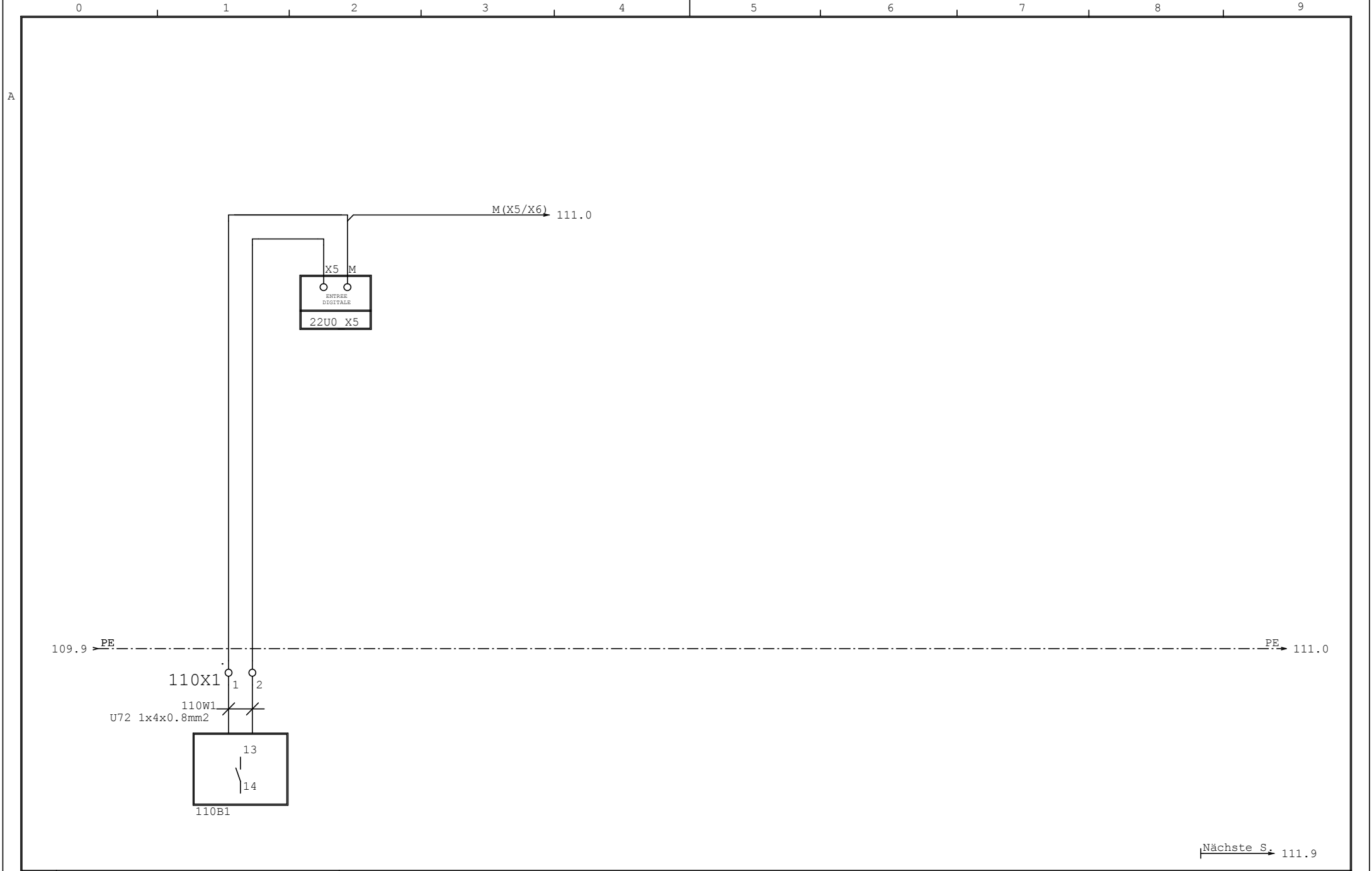

Nächste S. 111.9

|       |            |       |         |            |                    |   |                             |                                 |               |                        |  |
|-------|------------|-------|---------|------------|--------------------|---|-----------------------------|---------------------------------|---------------|------------------------|--|
|       |            |       | Datum   | 03.07.2014 | SCHAKO (SUISSE) SA |  | DIGITALEINGANG 10 (RESERVE) | NETZWERK. ZEHNDER 1 MAS. 2 MON. | =             |                        |  |
|       |            |       | Verant. |            |                    |   |                             |                                 |               | +                      |  |
|       |            |       | Kontr.  |            |                    |   |                             |                                 | 1762 Givisiez |                        |  |
| Vers. | Modifikat. | Datum | Name    | Norme      | Original           | Ersetzt:  | Ersetzt von:                |                                 | 200008_s041   | Folio 110<br>von 126S. |  |

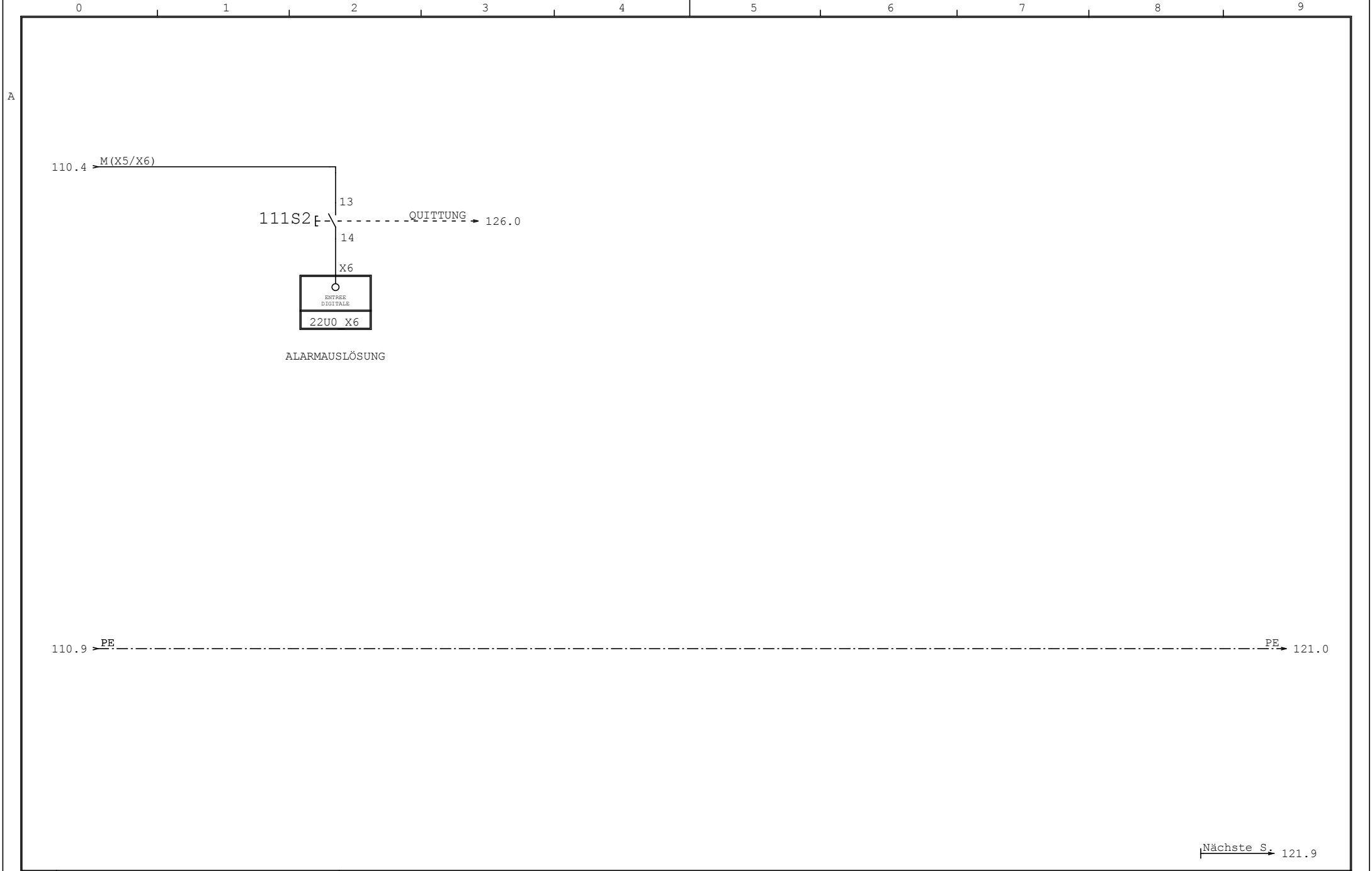

|       |            |       |         |            |                    |   |                |                                 |           |           |
|-------|------------|-------|---------|------------|--------------------|---|----------------|---------------------------------|-----------|-----------|
|       |            |       | Datum   | 03.07.2014 | SCHAKO (SUISSE) SA |  | ALARMAUSLÖSUNG | NETZWERK. ZEHNDER 1 MAS. 2 MON. | =         |           |
|       |            |       | Verant. |            | 1762 Givisiez      |   |                |                                 | +         |           |
|       |            |       | Kontr.  |            |                    |   |                |                                 |           |           |
| Vers. | Modifikat. | Datum | Name    | Norme      | Original           | Ersetzt:  | Ersetzt von:   | 200008_s041                     | Folio 111 | von 126S. |

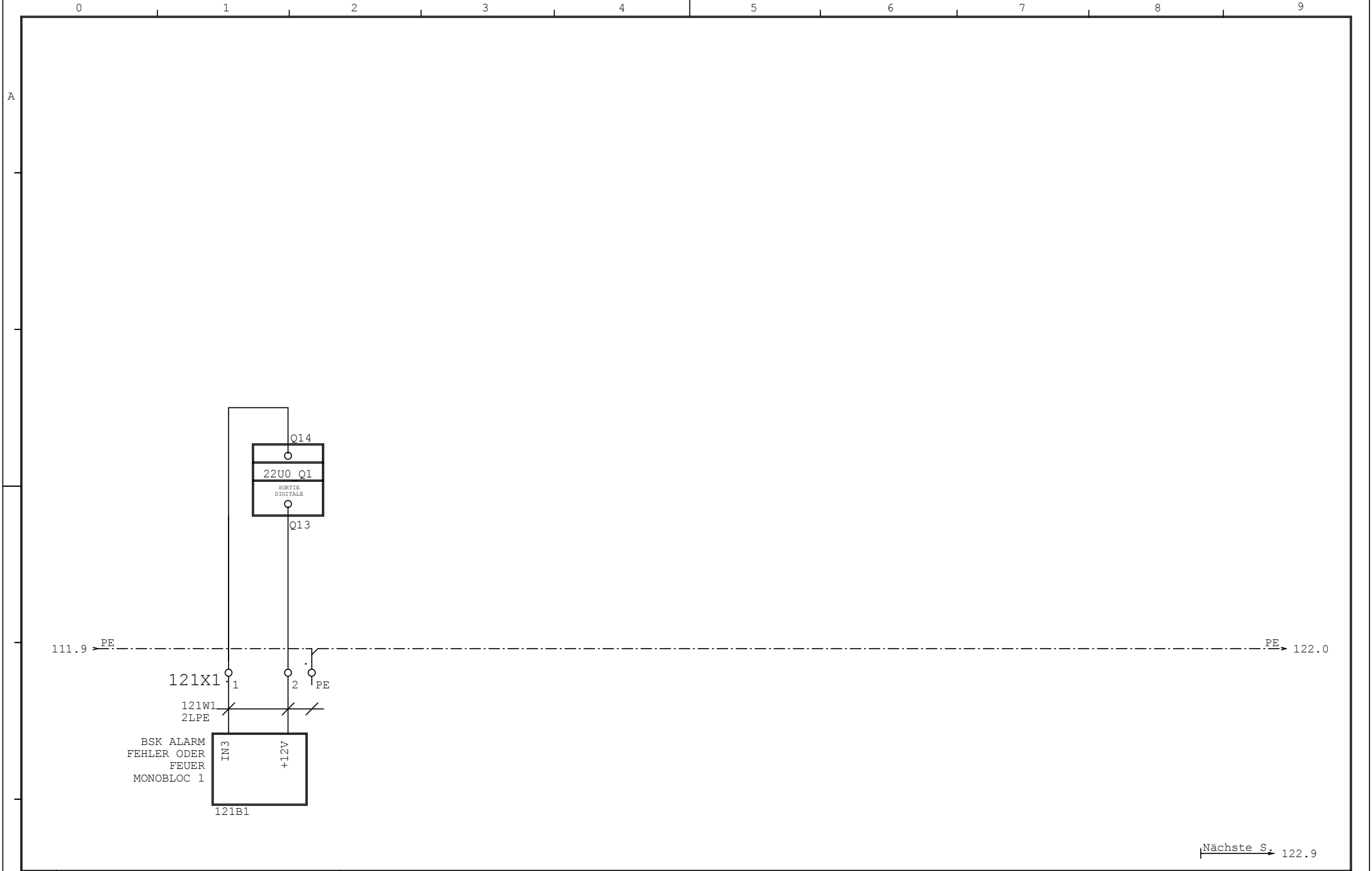

Nächste S. 122.9

|       |            |       |         |            |                                     |   |   |                                 |           |           |
|-------|------------|-------|---------|------------|-------------------------------------|---|---|---------------------------------|-----------|-----------|
|       |            |       | Datum   | 03.07.2014 | SCHAKO (SUISSE) SA<br>1762 Givisiez |  | BSK ALARM FEHLER ODER<br>FEUER MONOBLOC 1 | NETZWERK. ZEHNDER 1 MAS. 2 MON. | =         |           |
|       |            |       | Verant. |            |                                     |   |   |                                 | +         |           |
|       |            |       | Kontr.  |            |                                     |   |   |                                 |           |           |
| Vers. | Modifikat. | Datum | Name    | Norme      | Original                            | Ersetzt:  | Ersetzt von:                              | 200008_s041                     | Folio 121 | von 126S. |

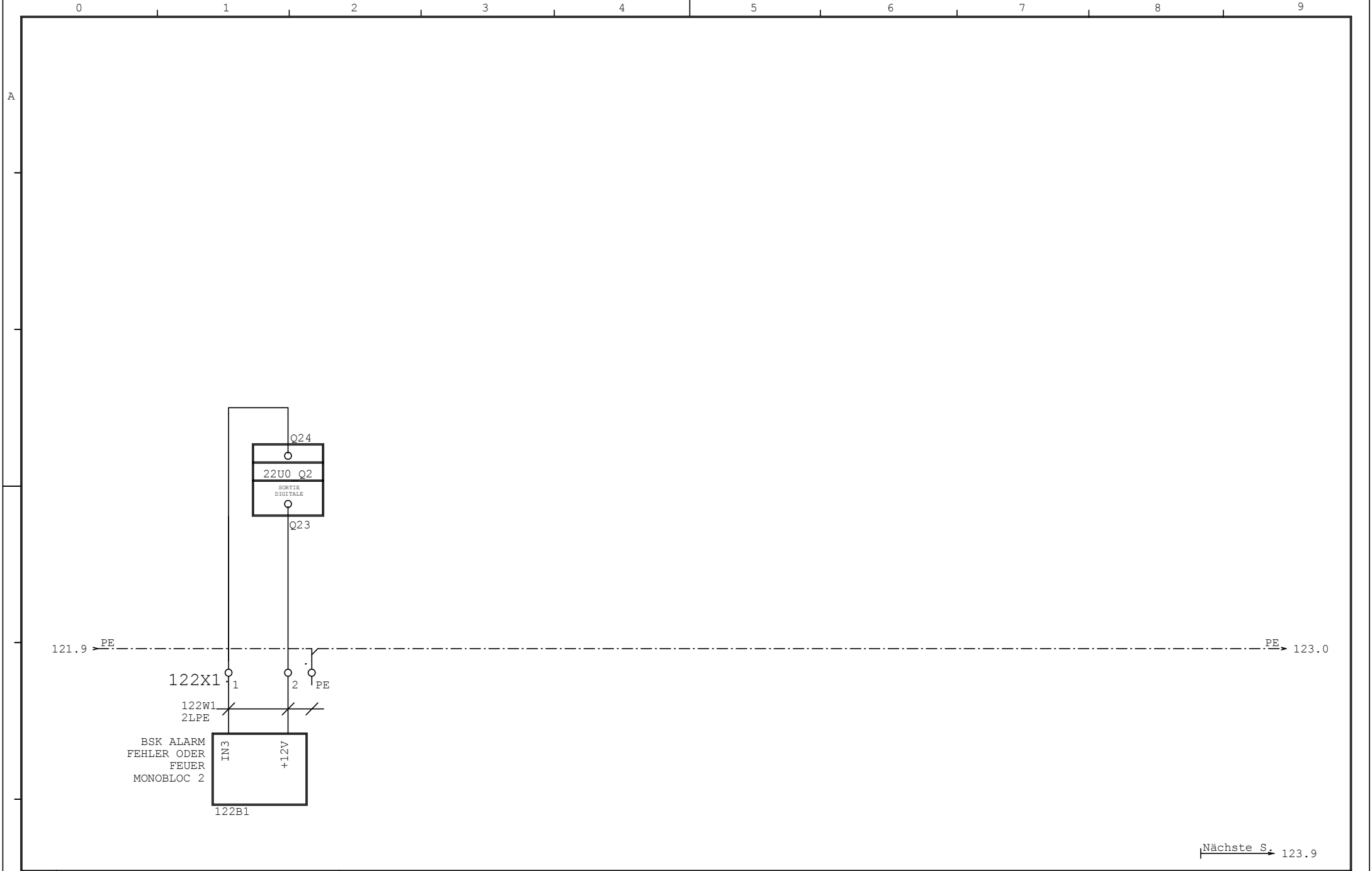

Nächste S. 123.9

|       |            |       |      |         |            |                    |              |   |  |             |                                 |           |   |
|-------|------------|-------|------|---------|------------|--------------------|--------------|---|--|-------------|---------------------------------|-----------|---|
|       |            |       |      | Datum   | 03.07.2014 | SCHAKO (SUISSE) SA |              |  | BSK ALARM FEHLER ODER FEUER MONOBLOC 2 |             | NETZWERK. ZEHNDER 1 MAS. 2 MON. |           | = |
|       |            |       |      | Verant. |            | 1762 Givisiez      |              |   |  |             |                                 |           | + |
|       |            |       |      | Kontr.  |            |                    |              |   |  |             |                                 |           |   |
| Vers. | Modifikat. | Datum | Name | Norme   | Original   | Ersetzt:           | Ersetzt von: |   |  | 200008_s041 |                                 | Folio 122 |   |
|       |            |       |      |         |            |                    |              |   |  |             |                                 | von 126S. |   |



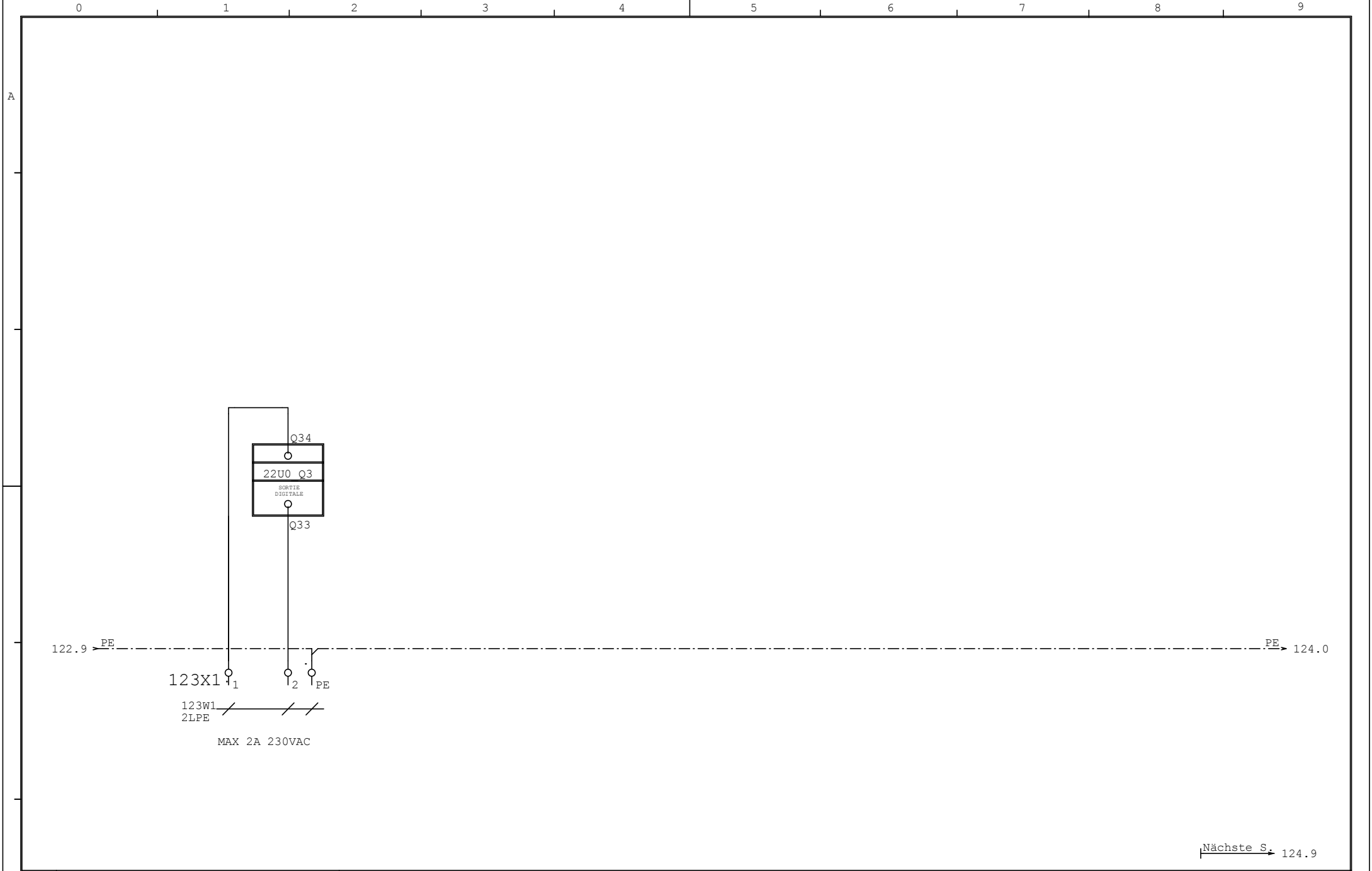

Nächste S. 124.9

|       |            |       |         |            |                    |          |   |                            |  |                                 |  |           |   |
|-------|------------|-------|---------|------------|--------------------|----------|---|----------------------------|--|---------------------------------|--|-----------|---|
|       |            |       | Datum   | 03.07.2014 | SCHAKO (SUISSE) SA |          |  | DIGITALEINGANG 3 (RESERVE) |  | NETZWERK. ZEHNDER 1 MAS. 2 MON. |  | =         |   |
|       |            |       | Verant. |            | 1762 Givisiez      |          |   |                            |  |                                 |  |           | + |
|       |            |       | Kontr.  |            |                    |          |   |                            |  |                                 |  |           |   |
| Vers. | Modifikat. | Datum | Name    | Norme      | Original           | Ersetzt: | Ersetzt von:  |                            |  | 200008_s041                     |  | Folio 123 |   |
|       |            |       |         |            |                    |          |   |                            |  |                                 |  | von 126S. |   |

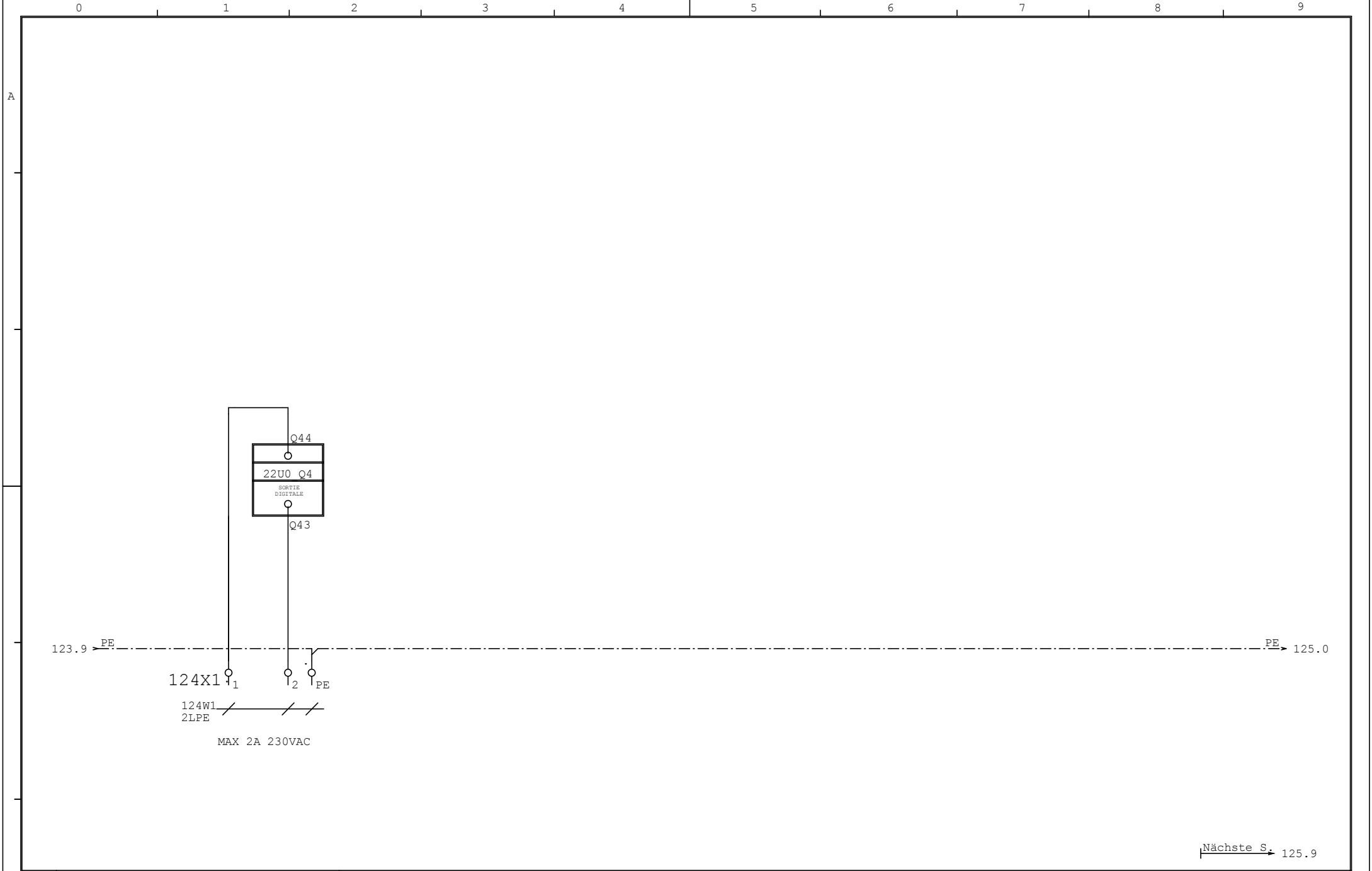

|       |            |       |      |         |            |                    |          |   |                            |  |                                 |  |           |           |
|-------|------------|-------|------|---------|------------|--------------------|----------|---|----------------------------|--|---------------------------------|--|-----------|-----------|
|       |            |       |      | Datum   | 03.07.2014 |                    |          |  | DIGITALEINGANG 4 (RESERVE) |  | NETZWERK. ZEHNDER 1 MAS. 2 MON. |  | =         |           |
|       |            |       |      | Verant. |            | SCHAKO (SUISSE) SA |          |   |                            |  |                                 |  | +         |           |
|       |            |       |      | Kontr.  |            | 1762 Givisiez      |          |   |                            |  |                                 |  |           | Folio 124 |
| Vers. | Modifikat. | Datum | Name | Norme   |            | Original           | Ersetzt: | Ersetzt von:  |                            |  | 200008_s041                     |  | von 126S. |           |

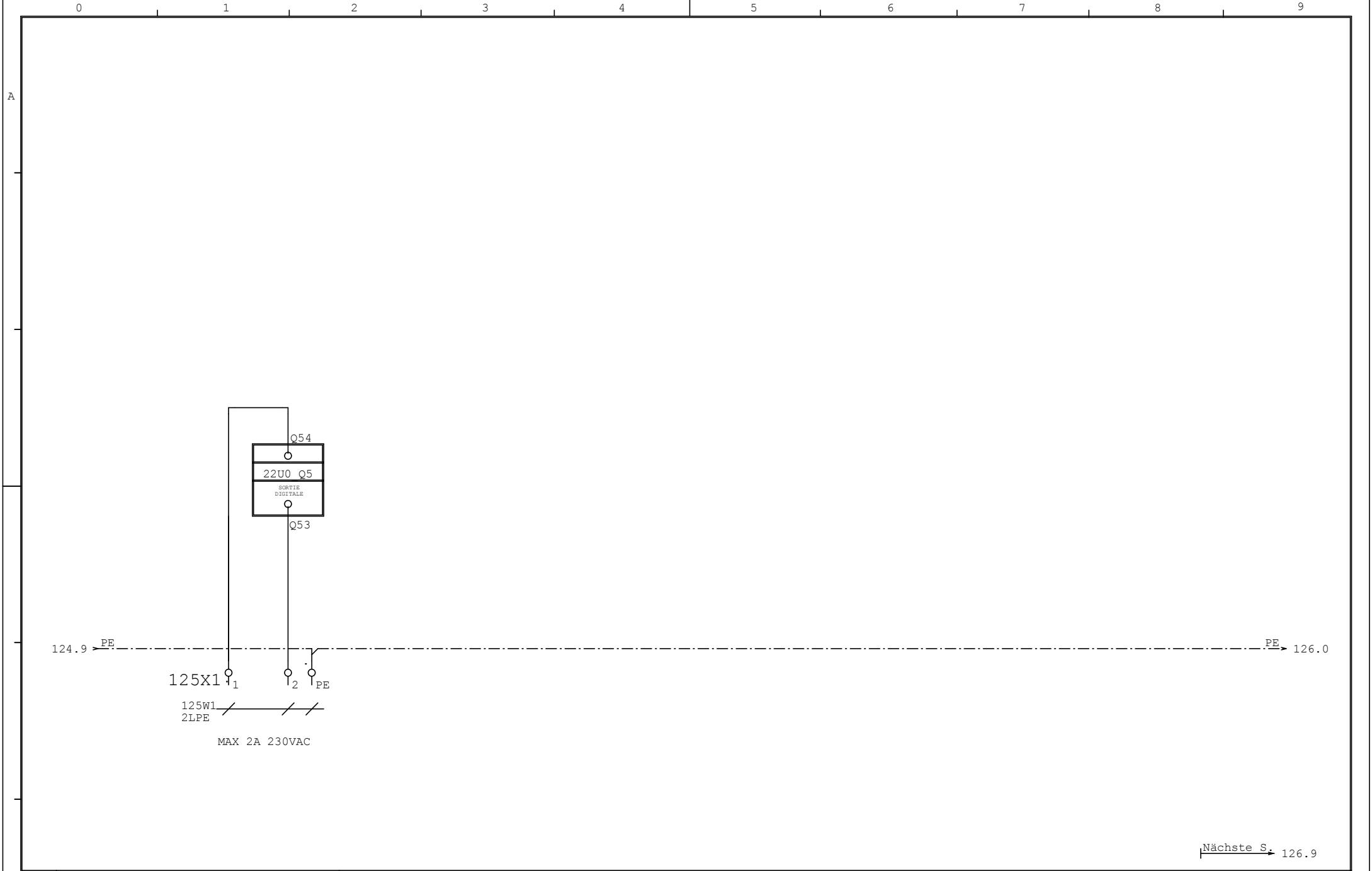

Nächste S. 126.9

|       |            |       |         |            |                                     |   |                            |                                 |             |                        |  |  |  |
|-------|------------|-------|---------|------------|-------------------------------------|---|----------------------------|---------------------------------|-------------|------------------------|--|--|--|
|       |            |       | Datum   | 03.07.2014 | SCHAKO (SUISSE) SA<br>1762 Givisiez |  | DIGITALEINGANG 5 (RESERVE) | NETZWERK. ZEHNDER 1 MAS. 2 MON. | =           |                        |  |  |  |
|       |            |       | Verant. |            |                                     |   |                            |                                 |             |                        |  |  |  |
|       |            |       | Kontr.  |            |                                     |   |                            |                                 |             |                        |  |  |  |
| Vers. | Modifikat. | Datum | Name    | Norme      | Original                            | Ersetzt:  | Ersetzt von:               |                                 | 200008_s041 | Folio 125<br>von 126S. |  |  |  |

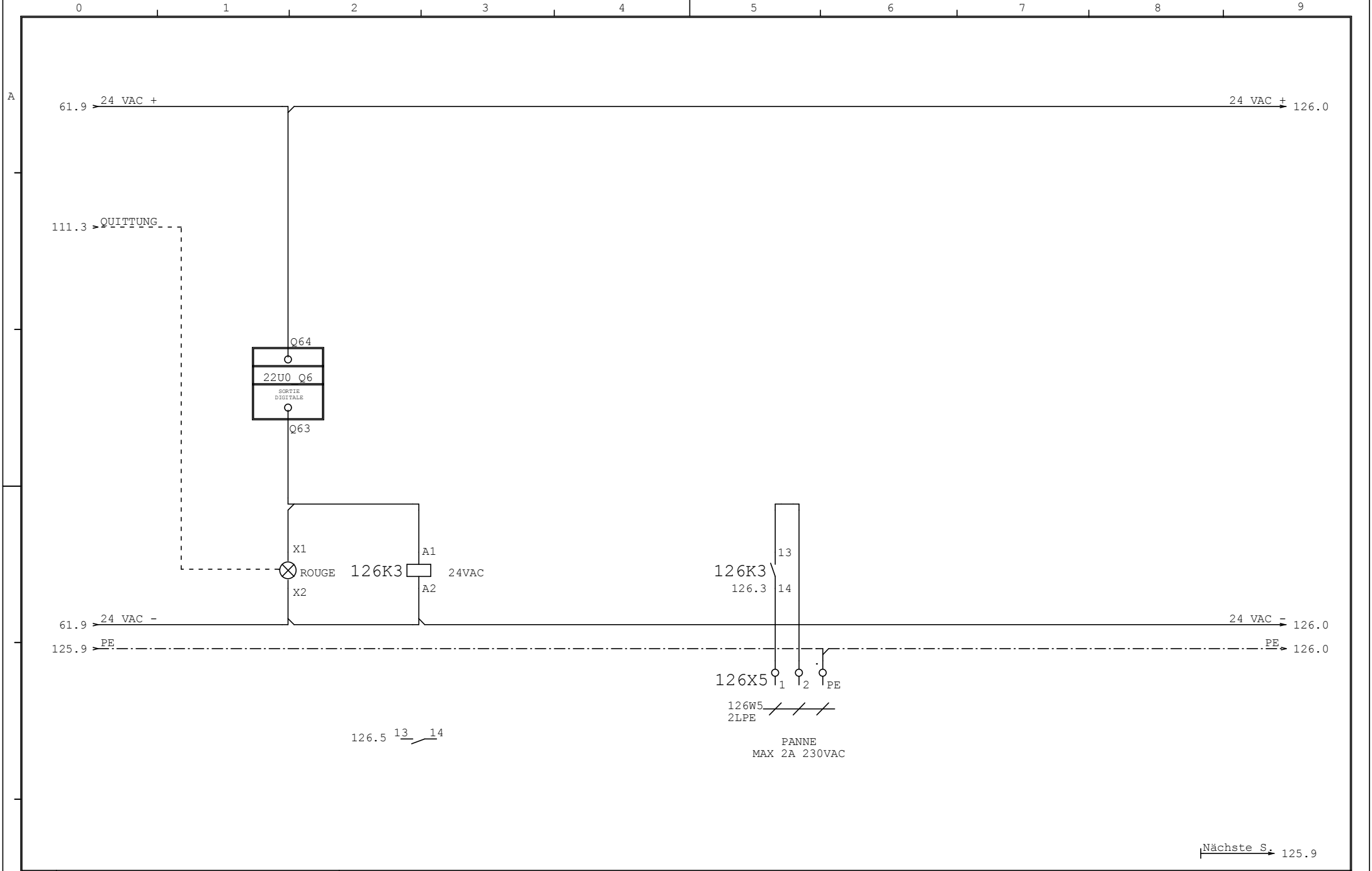

Nächste S. 125.9

|       |            |       |         |            |                    |          |   |              |                                 |           |           |
|-------|------------|-------|---------|------------|--------------------|----------|---|--------------|---------------------------------|-----------|-----------|
|       |            |       | Datum   | 03.07.2014 | SCHAKO (SUISSE) SA |          |  | PANNE        | NETZWERK. ZEHNDER 1 MAS. 2 MON. |           | =         |
|       |            |       | Verant. |            | 1762 Givisiez      |          |   |              |                                 |           | +         |
|       |            |       | Kontr.  |            | Original           |          |   | Ersetzt von: | 200008_s041                     |           | Folio 126 |
| Vers. | Modifikat. | Datum | Name    | Norme      | Original           | Ersetzt: | Ersetzt von:  |              |                                 | von 126S. |           |