

KUNDE : INTEGRATOR

VERSION 2

PROJEKT : EASYBUS



BÜRO : SCHAKO SUISSE SA  
RUE JEAN PROUVE 28  
1762 GIVISIEZ

TEL : 026 460 88 00 FAX: 026 460 88 05

DIESES SCHEMA IST GEISTIGES  
EIGENTUM VON SCHAKO

ÄNDERUNGEN ODER ANPASSUNGEN  
SIND OHNE UNSERE  
AUSDRÜCKLICHE ZUSTIMMUNG  
NICHT ERLAUBT

DAS EMPFOHLENE MATERIAL  
MUSS GEMÄSS VORSCHRIFT  
DES HERSTELLERS  
MONTIERT WERDEN

DIE AUFGEFÜHRTEN KONTAKTE  
SIND OHNE SPANNUNG  
ANGEGEBEN

DIEMENSIONIEREN SIE DAS  
ANSCHLUSSKABEL LAUT  
ANGABEN DES  
ENERGIVERSORGERERS

INSTALLATION:

AUTOMAT : SIEMENS POL 638.70

NETZWERKBRÜCKE ZEHNDER  
1 MASTER 1 MONOBLOC

REV	NOM	DATE	REV	NOM	DATE
1	LOCHER D.	08.01.2014			
2	LOCHER D.	24.06.2014			

Nächste S. 20.9

		Datum	03.07.2014	SCHAKO (SUISSE) SA 1762 Givisiez		VORSATZBLATT	NETZWERK. ZEHNDER 1 MAS. 1 MON.	=	
		Verant.						+	
		Kontr.							
Vers.	Modifikat.	Datum	Name	Norme	Original	Ersetzt:	Ersetzt von:	200008_s04k	Folio 0 von 126 S.



# AUTOMAT

Nächste S. 22.9

			Datum	03.07.2014	SCHAKO (SUISSE) SA			AUTOMAT	NETZWERK. ZEHNDER 1 MAS. 1 MON.		=
			Verant.		1762 Givisiez						+
			Kontr.								
Vers.	Modifikat.	Datum	Name	Norme	Original	Ersetzt:	Ersetzt von:		200008_s04k		Folio 20 von 126S.

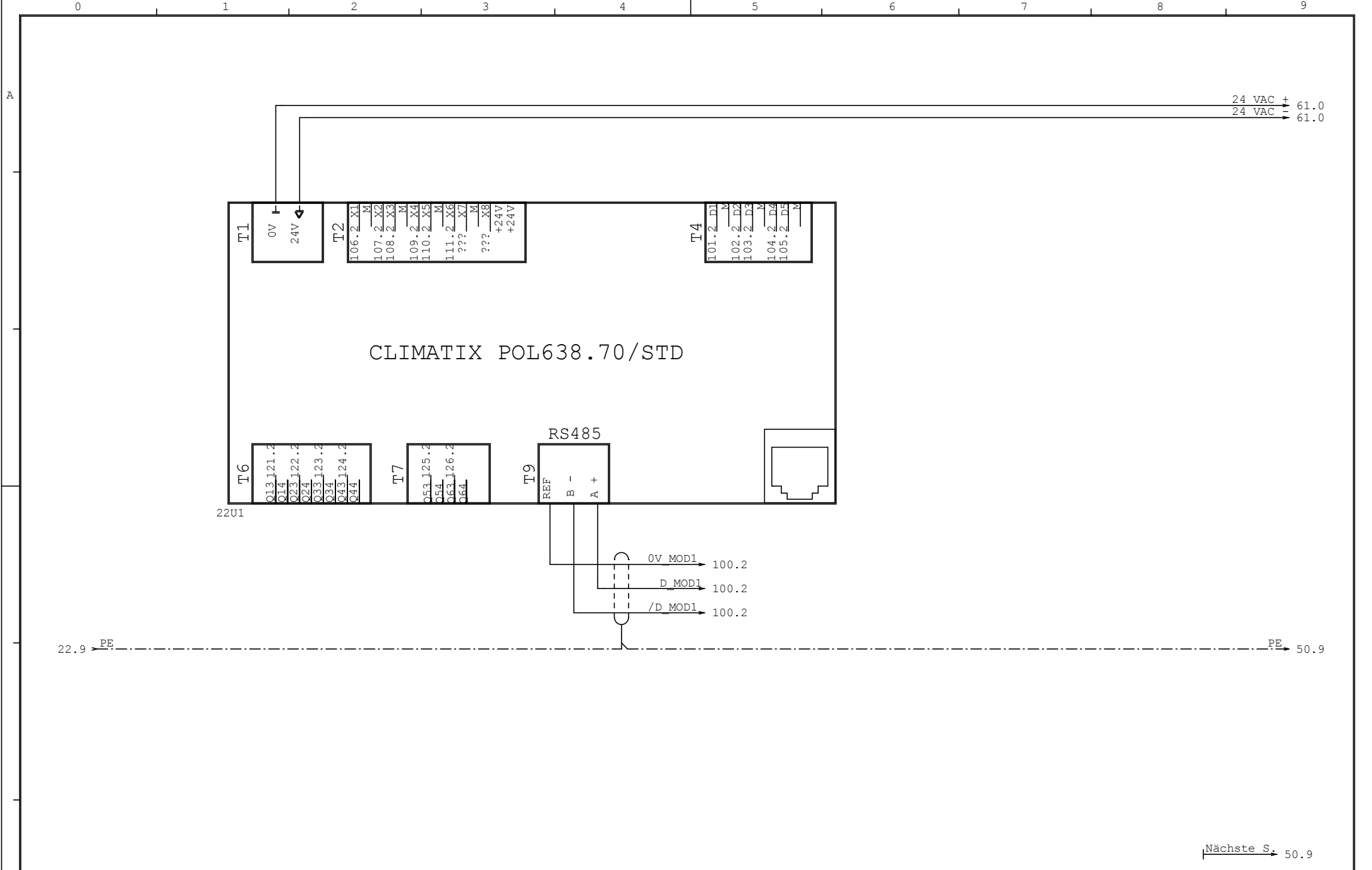

CLIMATIX POL638.70/STD

				Datum	03.07.2014										
				Verant.		SCHAKO (SUISSE) SA		NETZWERKBRÜCKE		NETZWERK. ZEHNDER 1 MAS. 1 MON.		=			
				Kontr.		1762 Givisiez						Folio 22			
Vers.	Modifikat.	Datum	Name	Norme	Original	Ersetztzt:	Ersetzt von:					200008_s04k	von 126S.		

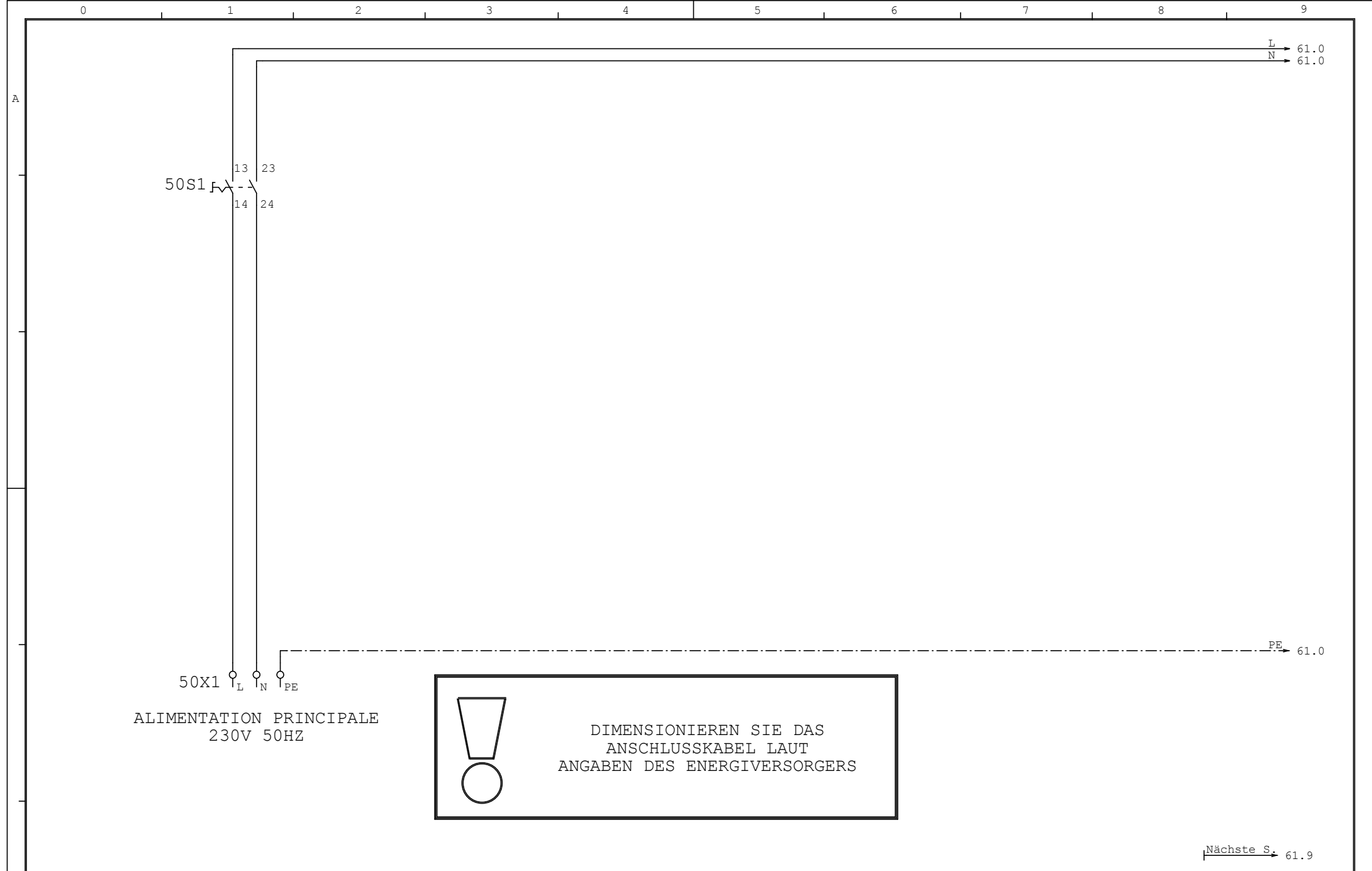

ALIMENTATION PRINCIPALE  
230V 50HZ



DIMENSIONIEREN SIE DAS  
ANSCHLUSSKABEL LAUT  
ANGABEN DES ENERGIVERSORGERS

Nächste S. 61.9

				Datum	03.07.2014	SCHAKO (SUISSE) SA		STROMVERSORGUNG 230V	NETZWERK. ZEHNDER 1 MAS. 1 MON.	=	
				Verant.		1762 Givisiez				+	
				Kontr.							Folio 50
Vers.	Modifikat.	Datum	Name	Norme	Original	Ersetzt:	Ersetzt von:		200008_s04k		von 126S.

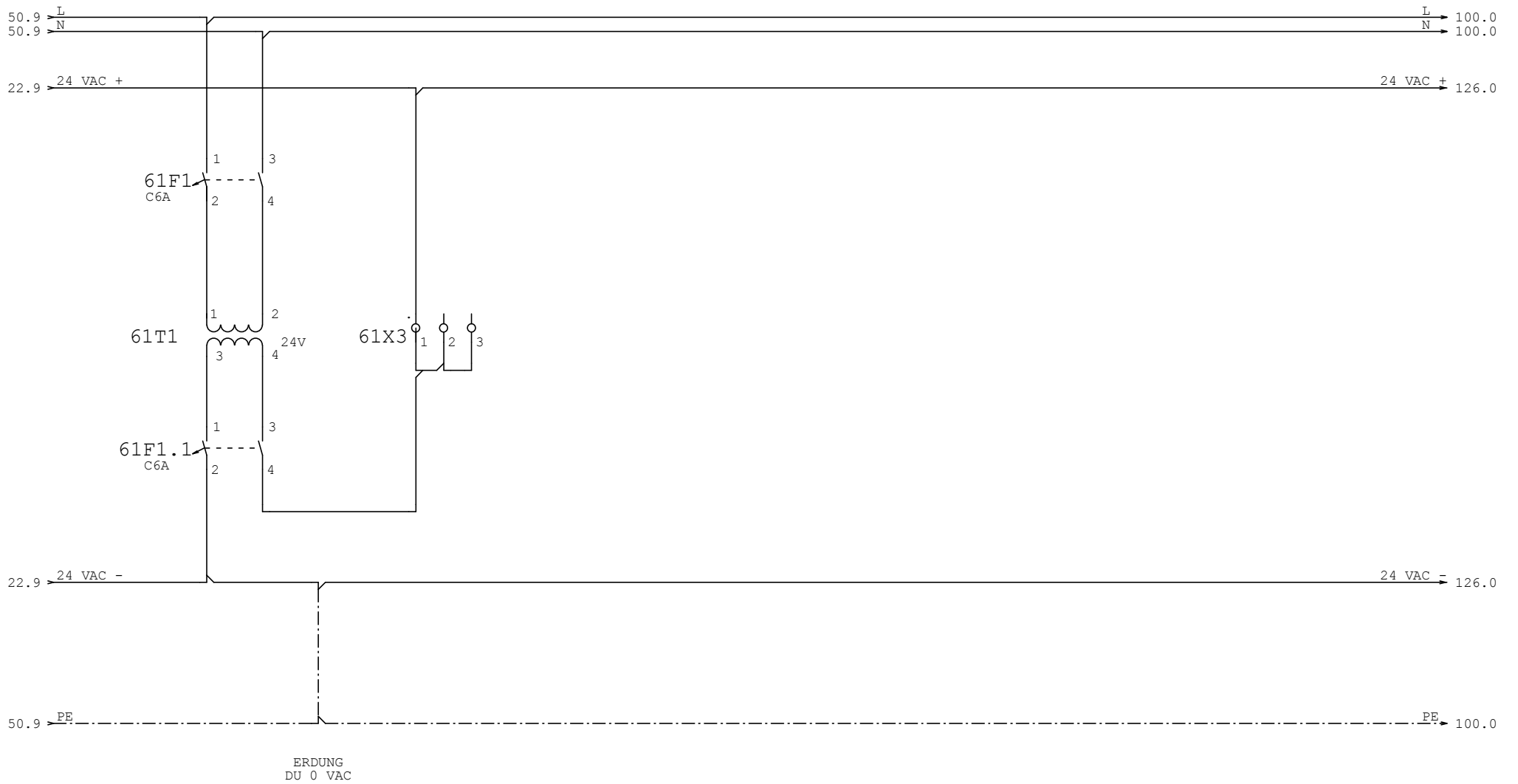

Nächste S. 99.9

			Datum	03.07.2014	SCHAKO (SUISSE) SA 1762 Givisiez		STROMVERSORGUNG 24 VAC	NETZWERK. ZEHNDER 1 MAS. 1 MON.	=	
			Verant.						+	
			Kontr.							
Vers.	Modifikat.	Datum	Name	Norme	Original	Ersetzt:	Ersetzt von:		200008_s04k	Folio 61 von 126S.

# EASYBUS BSK

Nächste S. 100.9

			Datum	03.07.2014	SCHAKO (SUISSE) SA			EASYBUS BSK	NETZWERK. ZEHNDER 1 MAS. 1 MON.		=	
			Verant.		1762 Givisiez							+
			Kontr.									
Vers.	Modifikat.	Datum	Name	Norme	Original	Ersetzt:	Ersetzt von:		200008_s04k		Folio 99 von 126S.	

61.9 L → 100.0  
 61.9 N → 100.0  
 61.9 PE → 101.0

**!**  
 WENN MEHRERE MASTER DAN  
 KANNÄLE AM MASTER UND AN  
 SEINEM EASYBUS NETZ WECHSELN

BEISPIEL HIER : FREQ = 1 CANAL = 1

MAXIMAL TEILNEHMER = 128  
 MAXIMALE BUSLÄNGE = 1000M

ALLE TOPOLOGIE ZUGELASSEN

DER FILTER MUSS MINIMAL > 50CM  
 EINEM FREQUENZVARIATOR  
 INSTALLIERT WERDEN

RS-485 / 232  
 MODBUS RTU  
 BAUDRATE=19200  
 BITS=8-E-2  
 ADRESSE=1

AM AUTOMAT

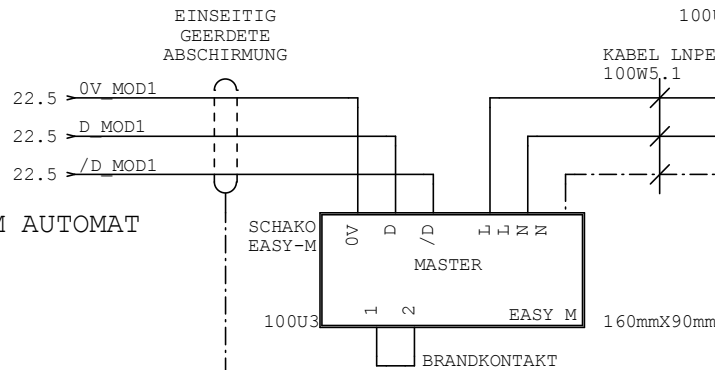

61.9 PE → 101.0

KABEL DIREKT AM FILTER  
 ANSCHLIESSEN. ZWISCHEN DIE  
 ANSCHLUSSDOSE UND DEN FILTER  
 MÜSSEN KEINE KLEMMEN  
 ANGESCHLOSSEN WERDEN.  
 MINIMUM 3X2.5MM2

INTERN SCHALTSCHRANK  
 EXTERN SCHALTSCHRANK

**!**  
 DIEMENSIONIEREN SIE DAS  
 ANSCHLUSSKABEL LAUT  
 ANGABEN DES  
 ENERGIVERSORGERS

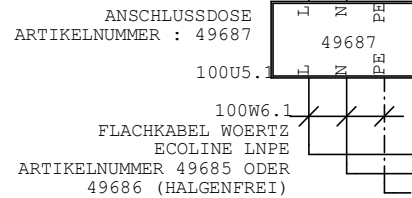

L EASY → 100a.0  
 N EASY → 100a.0  
 PE EE → 100a.0

Nächste S. → 100a.9

Datum	03.07.2014	SCHAKO (SUISSE) SA	EASY MASTER	NETZWERK. ZEHNDER 1 MAS. 1 MON.	=			
Verant.		1762 Givisiez			+			
Kontr.								
Vers.	Modifikat.	Datum	Name	Original	Ersetzt:	Ersetzt von:	200008_s04k	Folio 100
								von 126S.



INTERN SCHALTSCHRANK  
 EXTERN SCHALTSCHRANK

ANSCHLUSSDOSE 3x2.5mm<sup>2</sup>  
 ARTIKELNUMMER : 49695

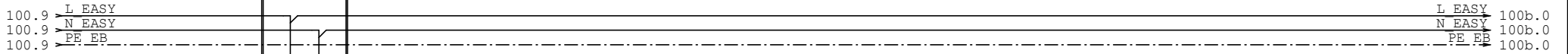

100aW2  
 TD 2x1

SCHAKO  
 EASY-B

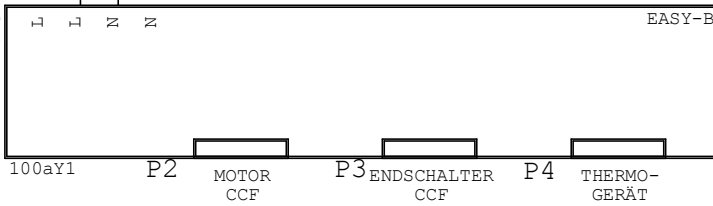

BEISPIEL HIER : FREQ = 1 CANAL = 1

ADRESSE : .....

Nächste S. 100b.9

Datum	03.07.2014	SCHAKO (SUISSE) SA			EASY-B	NETZWERK. ZEHNDER 1 MAS. 1 MON.	=		
Verant.		1762 Givisiez					+		
Kontr.									
Vers.	Modifikat.	Datum	Name	Norme	Original	Ersetzt:	Ersetzt von:	200008_s04k	Folio 100a von 126 S.

INTERN SCHALTSCHRANK  
 EXTERN SCHALTSCHRANK

ANSCHLUSSDOSE 3x2.5mm<sup>2</sup>  
 ARTIKELNUMMER : 49695

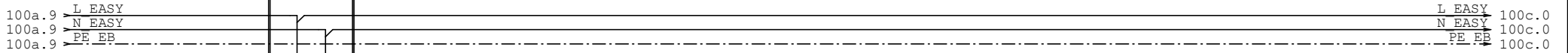

100bW2  
 TD 2x1

SCHAKO  
 EASY-B  
 230V

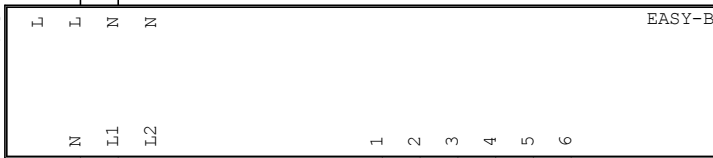

100by1

100bW2  
 TD 2x1

CCF



100by1.1

100bW3  
 TD 6x1

BEISPIEL HIER : FREQ = 1 CANAL = 1

ADRESSE : .....

Nächste S. 100c.9

Datum	03.07.2014	SCHAKO (SUISSE) SA 1762 Givisiez		EASY-B 230V	NETZWERK. ZEHNDER 1 MAS. 1 MON.	=	+		
Verant.									
Kontr.									
Vers.	Modifikat.	Datum	Name	Norme	Original	Ersetzt:	Ersetzt von:	200008_s04k	Folio 100b von 126 S.

A

INTERN SCHALTSCHRANK  
 EXTERN SCHALTSCHRANK

ANSCHLUSSDOSE 3x2.5mm2  
 ARTIKELNUMMER : 49695

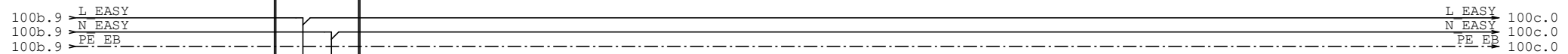

100cW2  
 TD 2x1

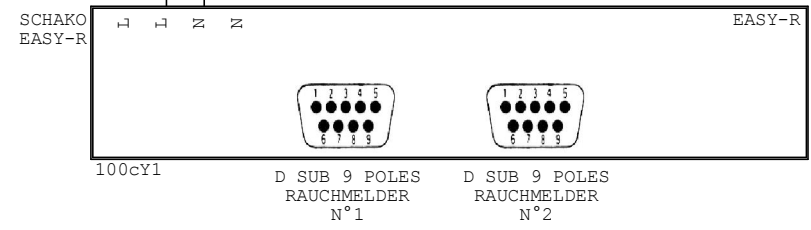

BEISPIEL HIER : FREQ = 1 CANAL = 1

ADRESSE : .....

Nächste S. 101.9

F

			Datum	03.07.2014	SCHAKO (SUISSE) SA 1762 Givisiez		EASY-R	NETZWERK. ZEHNDER 1 MAS. 1 MON.	=		
			Verant.							+	
			Kontr.								
Vers.	Modifikat.	Datum	Name	Norme	Original	Ersertzt:	Ersetzt von:	200008_s04k	Folio 100c	von 126 S.	

F

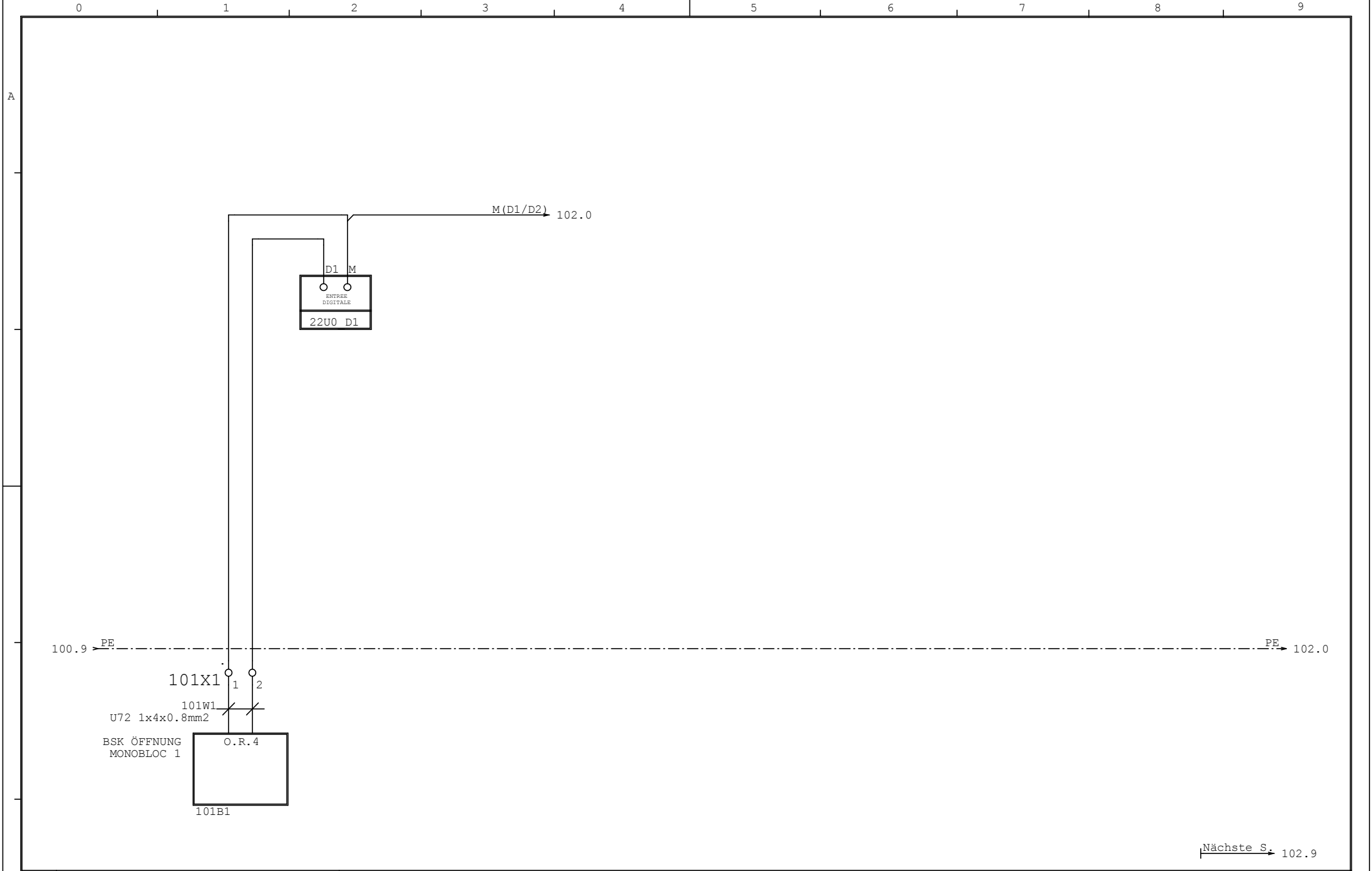

Nächste S. 102.9

				Datum	03.07.2014				BSK ÖFFNUNG MONOBLOC 1		NETZWERK. ZEHNDER 1 MAS. 1 MON.		=	
				Verant.		SCHAKO (SUISSE) SA							+	
				Kontr.		1762 Givisiez							Folio 101	
Vers.	Modifikat.	Datum	Name	Norme		Original	Ersetzt:	Ersetzt von:			200008_s04k		von 126S.	

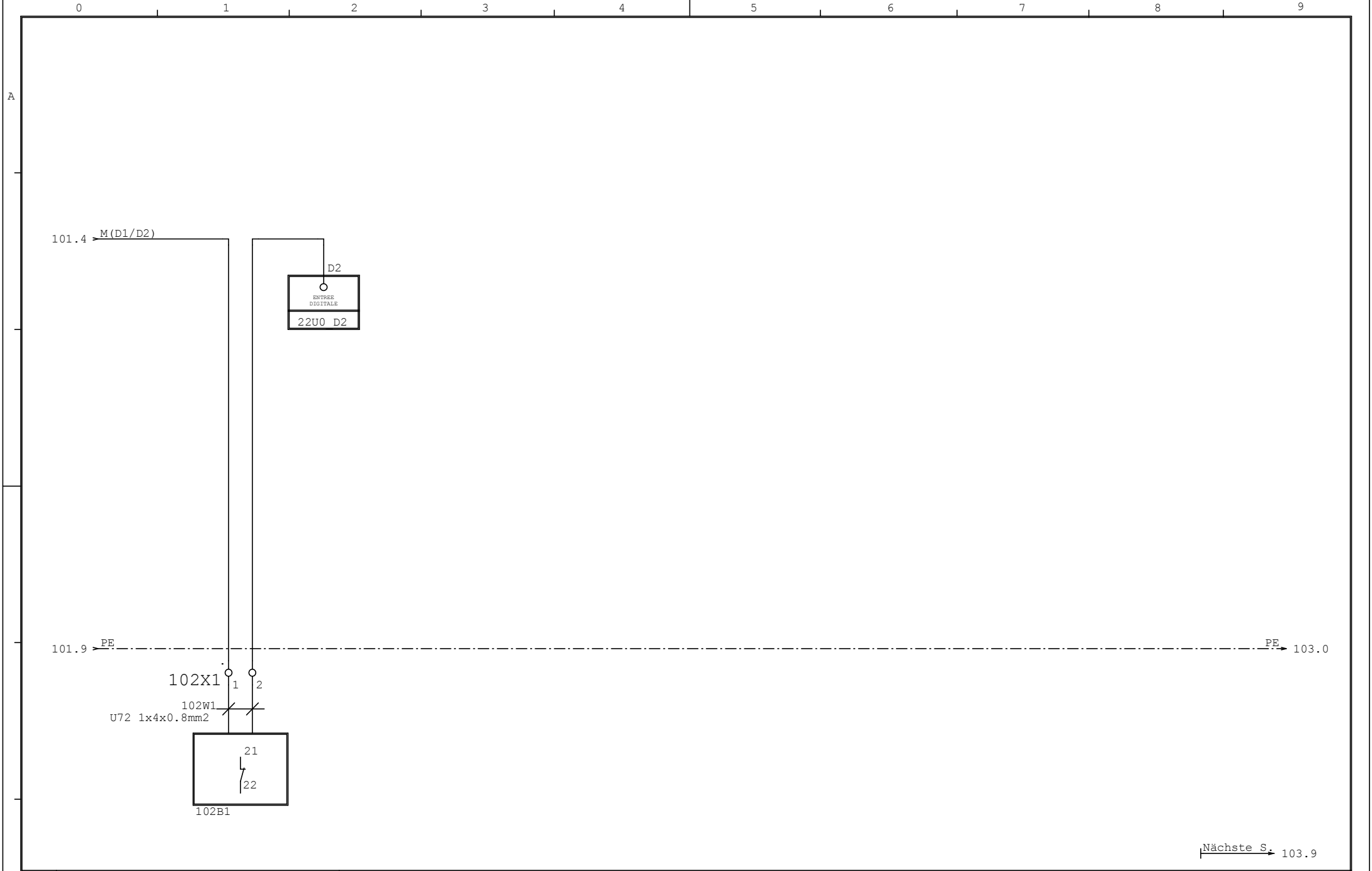

Nächste S. 103.9

			Datum	03.07.2014	SCHAKO (SUISSE) SA 1762 Givisiez		DIGITALEINGANG 2 (RESERVE)	NETZWERK. ZEHNDER 1 MAS. 1 MON.	=		
			Verant.							+	
			Kontr.								
Vers.	Modifikat.	Datum	Name	Norme	Original	Ersetzt:	Ersetzt von:	200008_s04k	Folio 102	von 126S.	

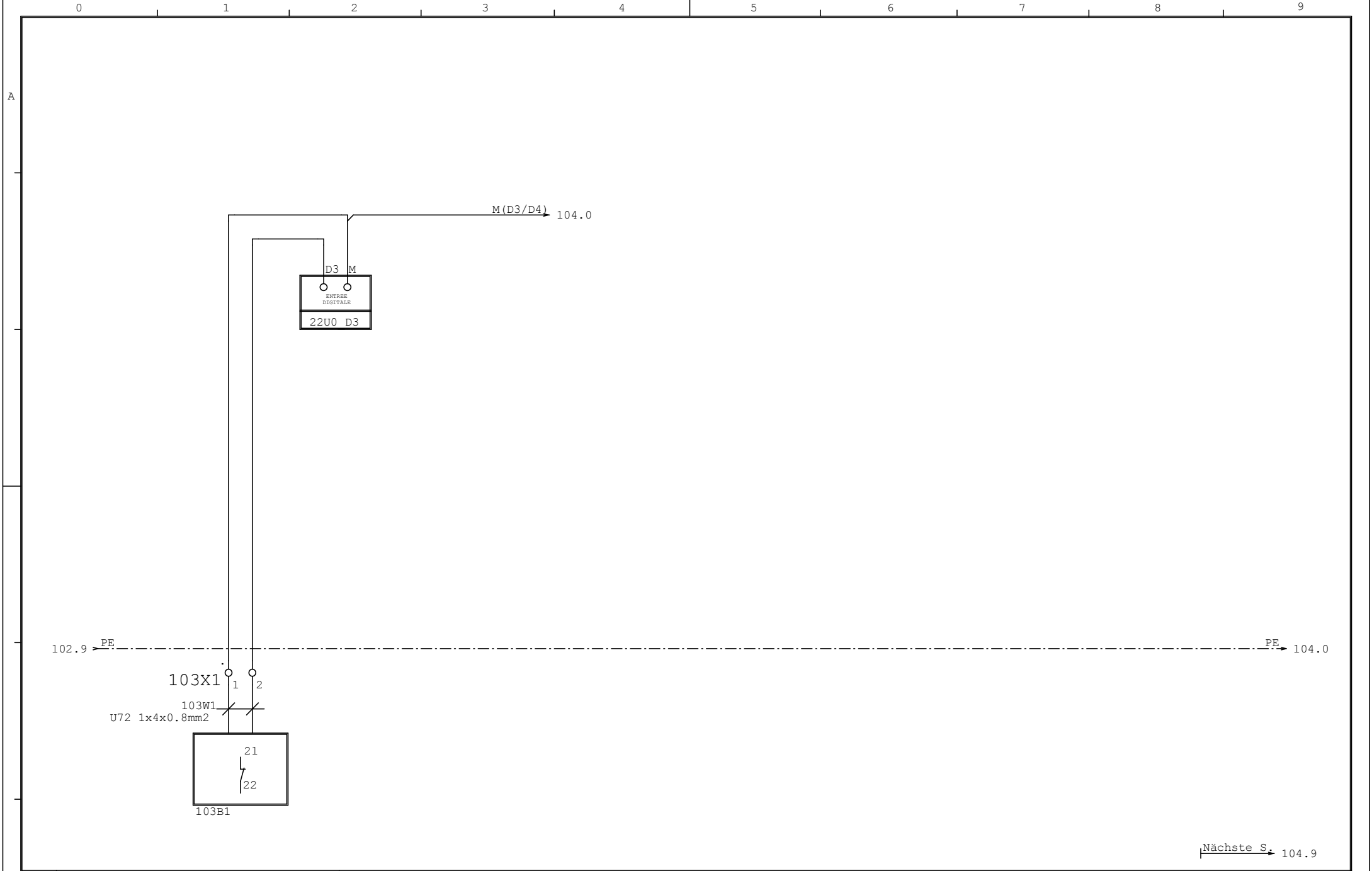

Nächste S. 104.9

			Datum	03.07.2014	SCHAKO (SUISSE) SA 1762 Givisiez		DIGITALEINGANG 3 (RESERVE)	NETZWERK. ZEHNDER 1 MAS. 1 MON.	=			
			Verant.									
			Kontr.									
Vers.	Modifikat.	Datum	Name	Norme	Original	Ersetzt:	Ersetzt von:		200008_s04k	Folio 103 von 126S.		

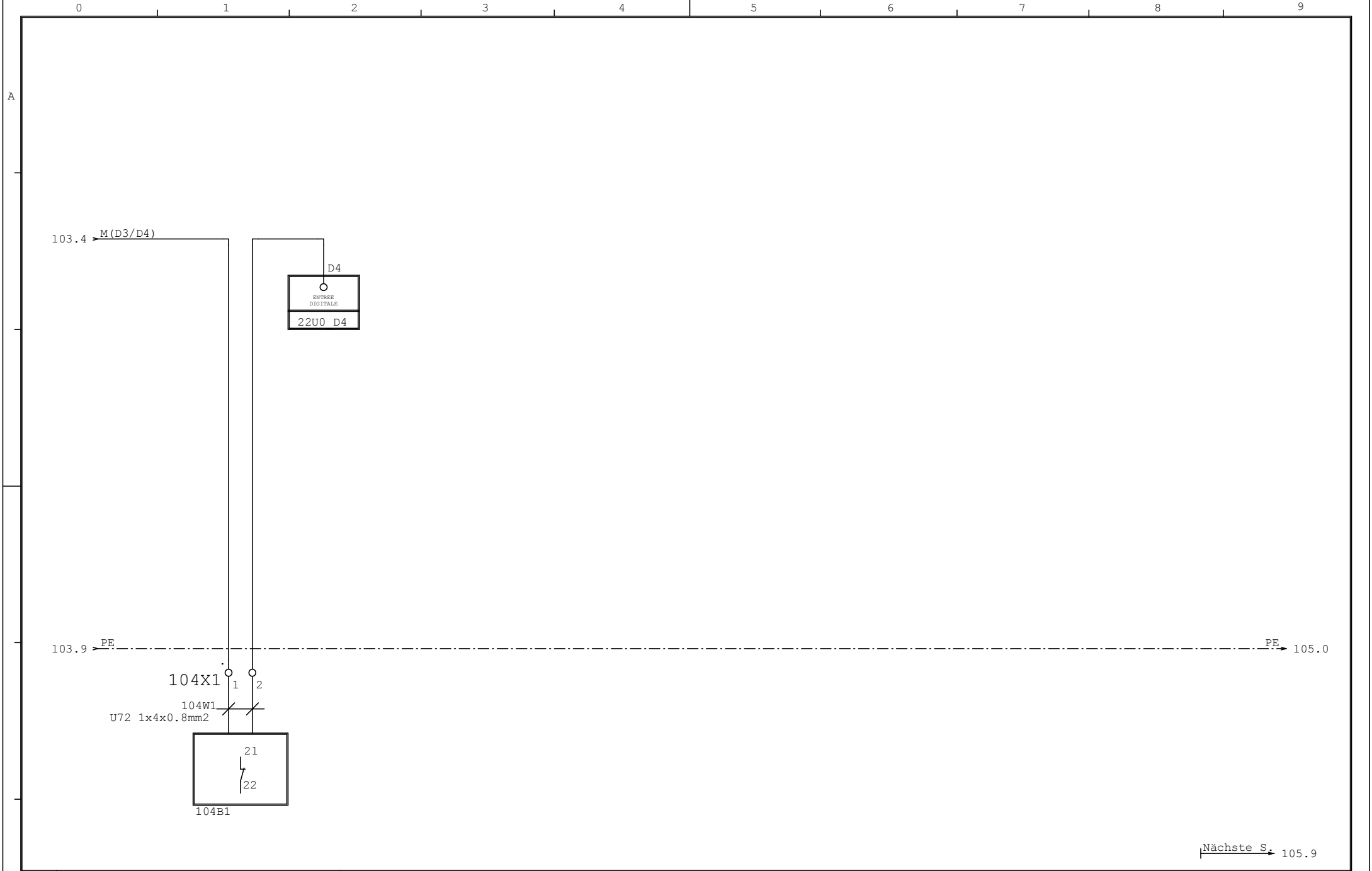

			Datum	03.07.2014	SCHAKO (SUISSE) SA		DIGITALEINGANG 4 (RESERVE)	NETZWERK. ZEHNDER 1 MAS. 1 MON.	=		
			Verant.		1762 Givisiez					+	
			Kontr.								
Vers.	Modifikat.	Datum	Name	Norme	Original	Ersetzt:	Ersetzt von:	200008_s04k		Folio 104 von 126S.	

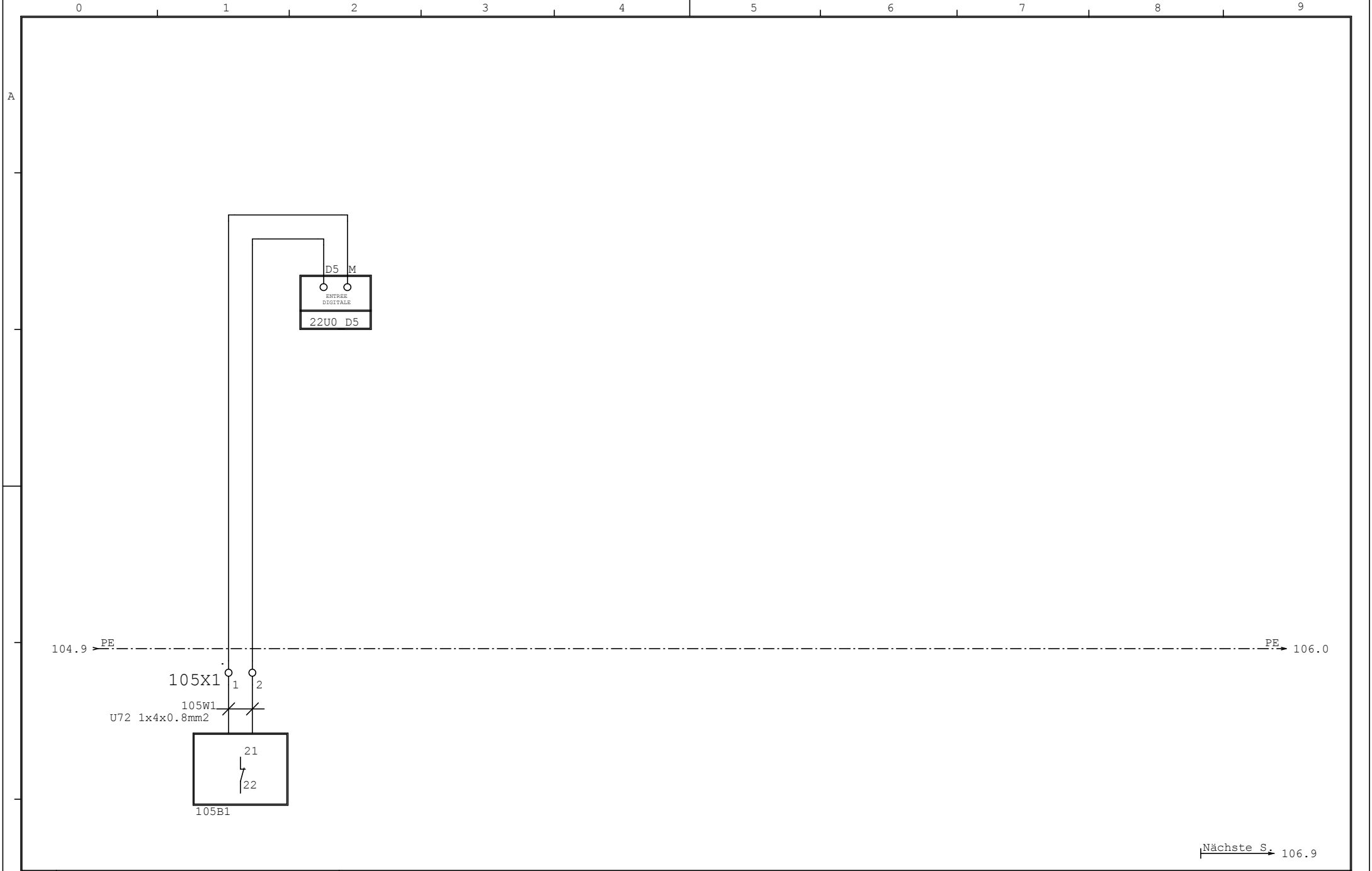

Nächste S. 106.9

			Datum	03.07.2014	SCHAKO (SUISSE) SA 1762 Givisiez		DIGITALEINGANG 5 (RESERVE)	NETZWERK. ZEHNDER 1 MAS. 1 MON.	=		
			Verant.							+	
			Kontr.								
Vers.	Modifikat.	Datum	Name	Norme	Original	Ersetzt:	Ersetzt von:		200008_s04k	Folio 105 von 126S.	



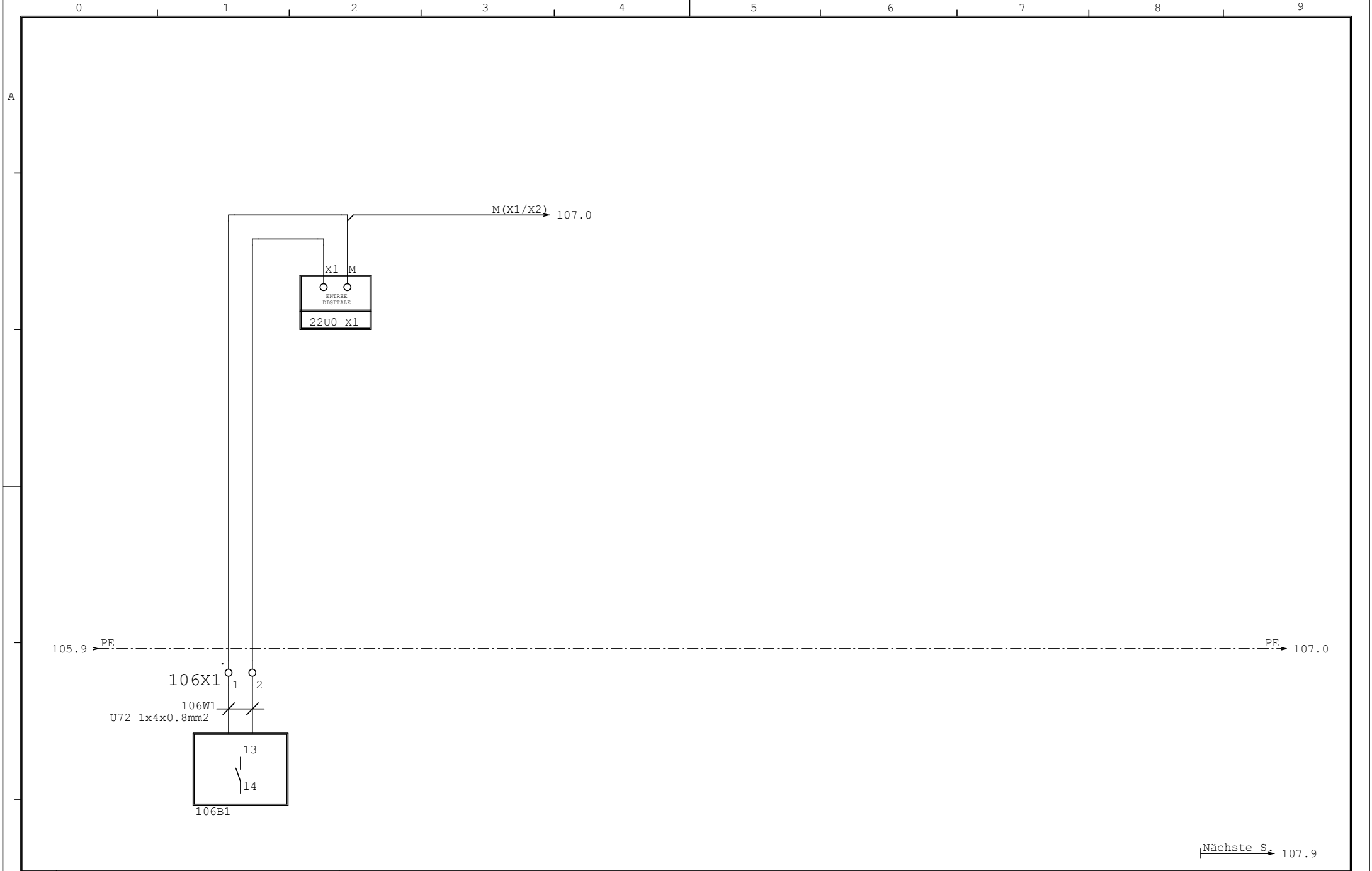

Nächste S. 107.9

			Datum	03.07.2014	SCHAKO (SUISSE) SA 1762 Givisiez		DIGITALEINGANG 6 (RESERVE)	NETZWERK. ZEHNDER 1 MAS. 1 MON.	=				
			Verant.										
			Kontr.										
Vers.	Modifikat.	Datum	Name	Norme	Original	Ersetzt:	Ersetzt von:		200008_s04k	Folio 106 von 126S.			

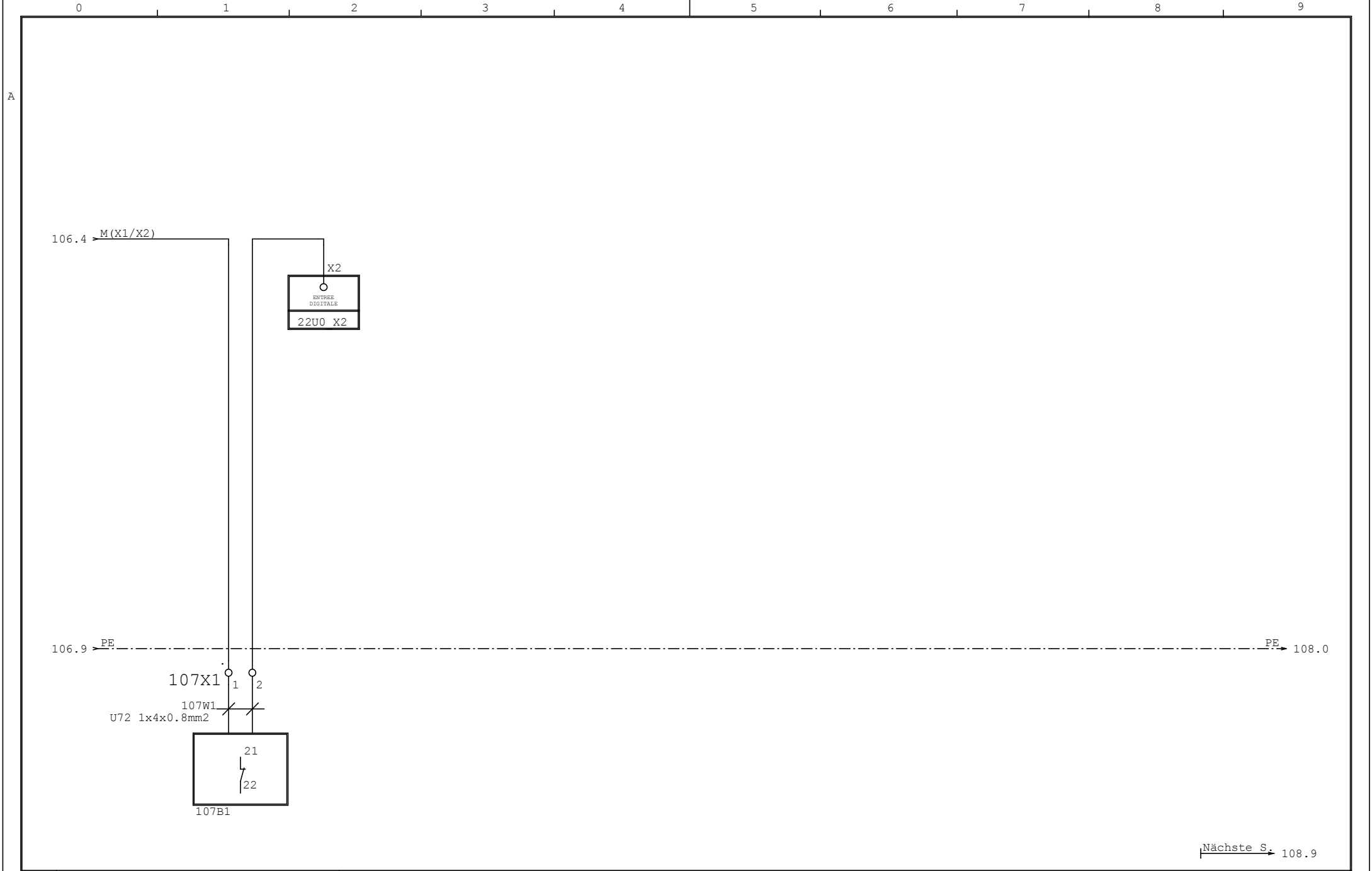

Nächste S. 108.9

			Datum	03.07.2014	SCHAKO (SUISSE) SA		DIGITALEINGANG 7 (RESERVE)	NETZWERK. ZEHNDER 1 MAS. 1 MON.	=		
			Verant.		1762 Givisiez					+	
			Kontr.								Folio 107
Vers.	Modifikat.	Datum	Name	Norme	Original	Ersetzt:	Ersetzt von:			200008_s04k	von 126S.

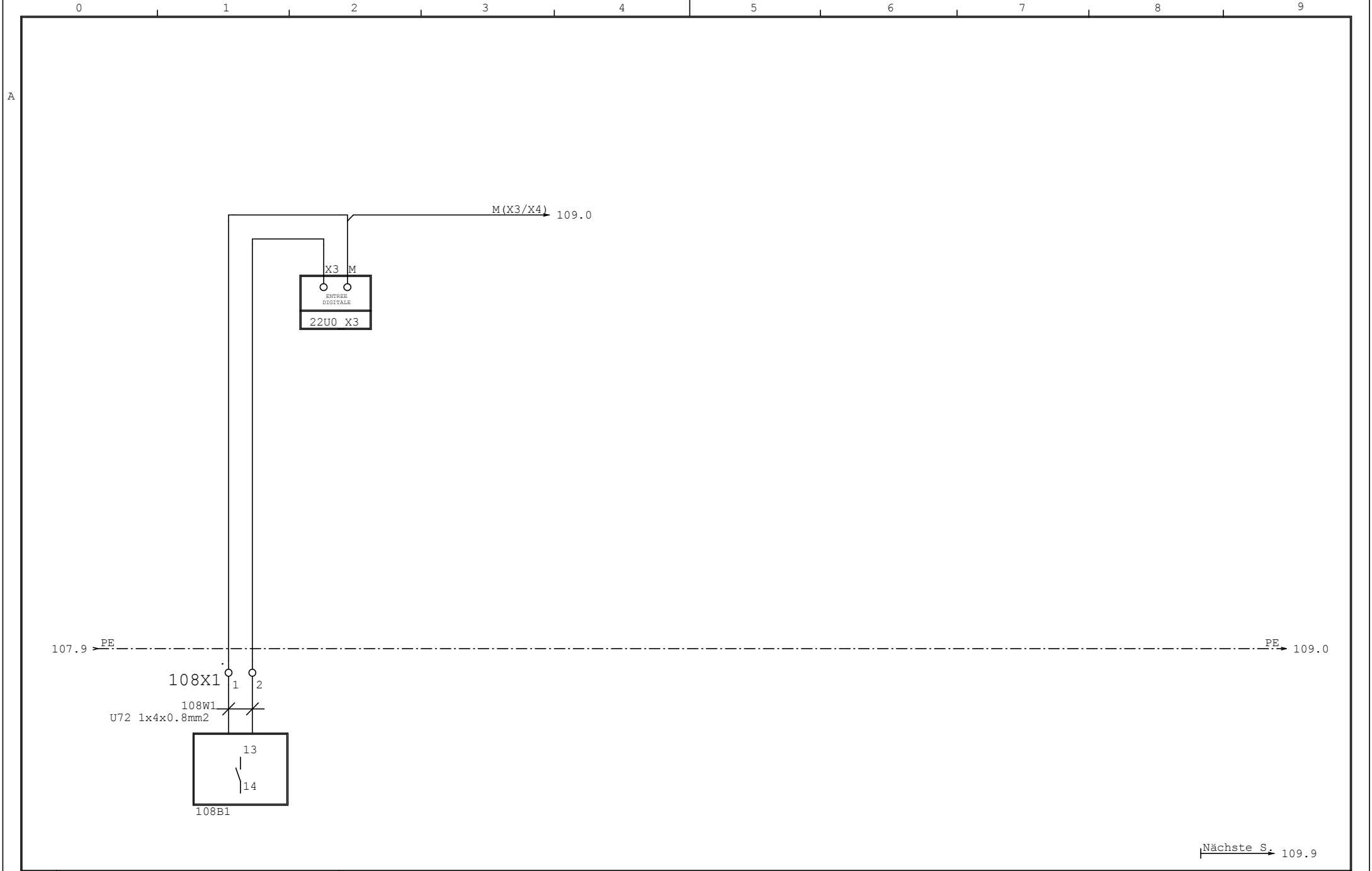

				Datum	03.07.2014				DIGITALEINGANG 8 (RESERVE)	NETZWERK. ZEHNDER 1 MAS. 1 MON.	=		
				Verant.		SCHAKO (SUISSE) SA						+	
				Kontr.		1762 Givisiez							Folio 108
Vers.	Modifikat.	Datum	Name	Norme		Original	Ersetzt:	Ersetzt von:		200008_s04k		von 126S.	

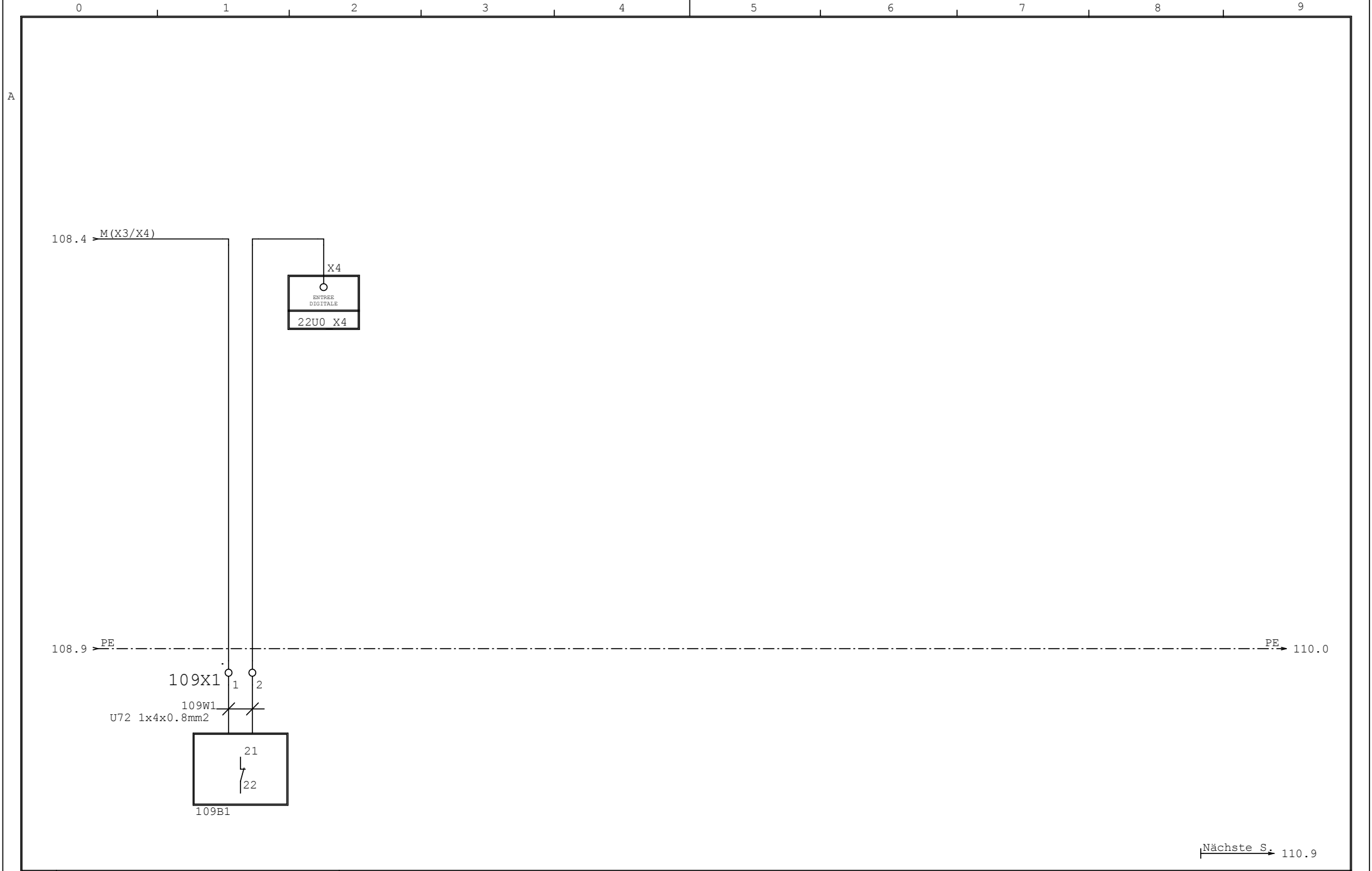

Nächste S. 110.9

			Datum	03.07.2014	SCHAKO (SUISSE) SA 1762 Givisiez		DIGITALEINGANG 9 (RESERVE)	NETZWERK. ZEHNDER 1 MAS. 1 MON.	=			
			Verant.									
			Kontr.									
Vers.	Modifikat.	Datum	Name	Norme	Original	Ersetzt:	Ersetzt von:		200008_s04k	Folio 109 von 126S.		

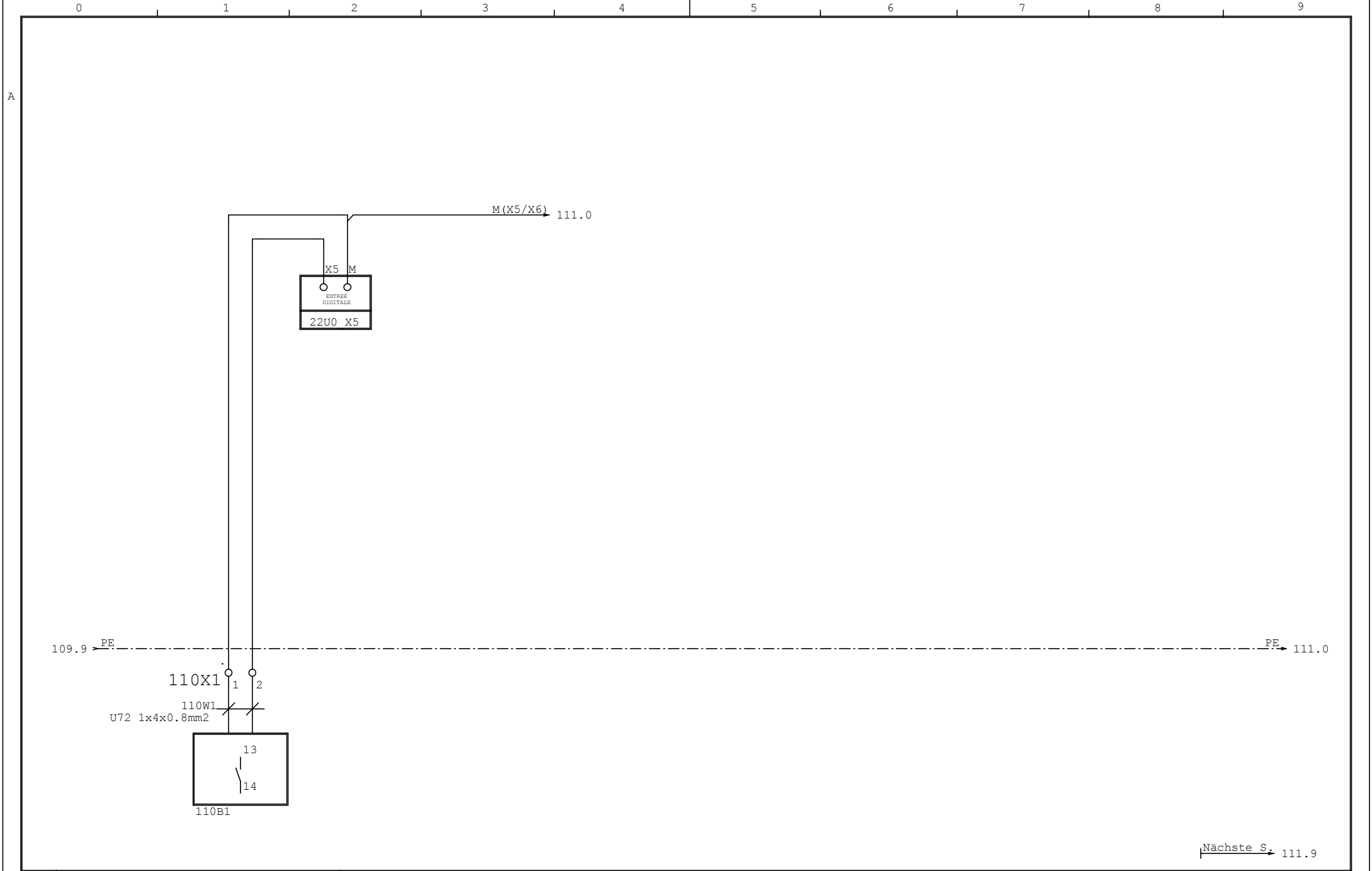

Nächste S. 111.9

			Datum	03.07.2014	SCHAKO (SUISSE) SA 1762 Givisiez		DIGITALEINGANG 10 (RESERVE)	NETZWERK. ZEHNDER 1 MAS. 1 MON.	=				
			Verant.									+	
			Kontr.										
Vers.	Modifikat.	Datum	Name	Norme	Original	Ersetzt:	Ersetzt von:		200008_s04k	Folio 110 von 126S.			

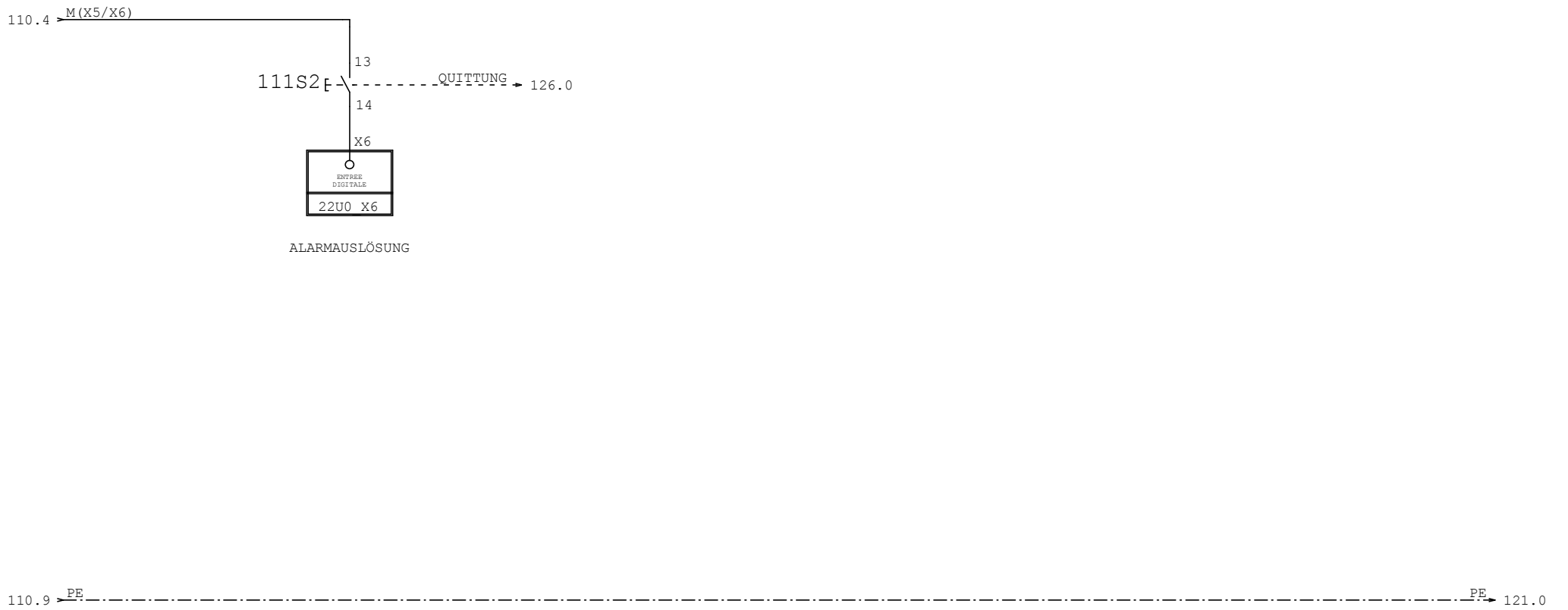

Nächste S. → 121.9

			Datum	03.07.2014	SCHAKO (SUISSE) SA			ALARMAUSLÖSUNG	NETZWERK. ZEHNDER 1 MAS. 1 MON.	=
			Verant.		1762 Givisiez					+
			Kontr.		Original	Ersetzt:		Ersetzt von:	200008_s04k	Folio 111
Vers.	Modifikat.	Datum	Name	Norme						von 126S.

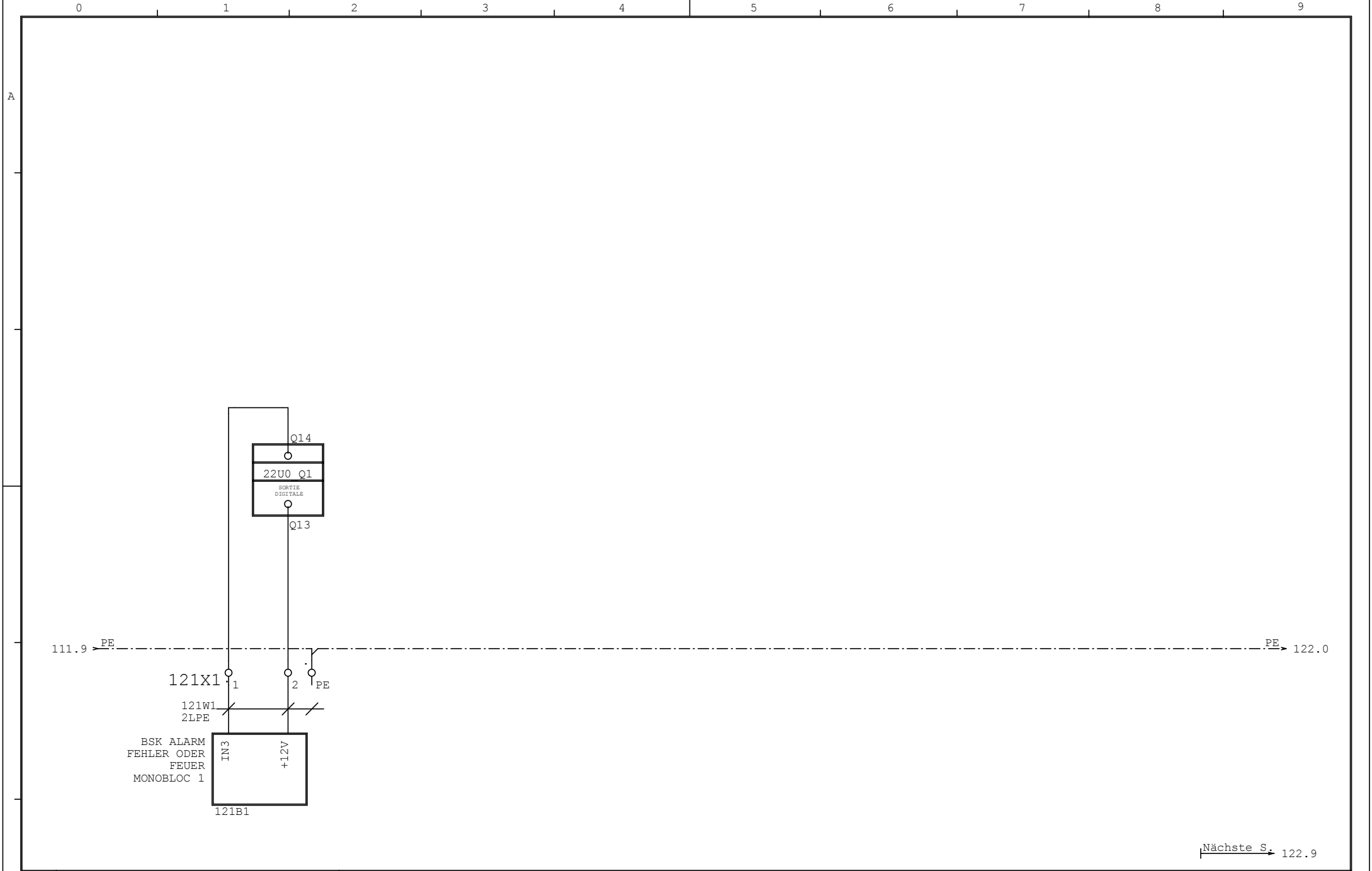

Nächste S. 122.9

			Datum	03.07.2014	SCHAKO (SUISSE) SA			BSK ALARM FEHLER ODER FEUER MONOBLOC 1		NETZWERK. ZEHNDER 1 MAS. 1 MON.		=
			Verant.		1762 Givisiez							+
			Kontr.									
Vers.	Modifikat.	Datum	Name	Norme	Original	Ersetzt:	Ersetzt von:	200008_s04k		Folio 121		von 126S.

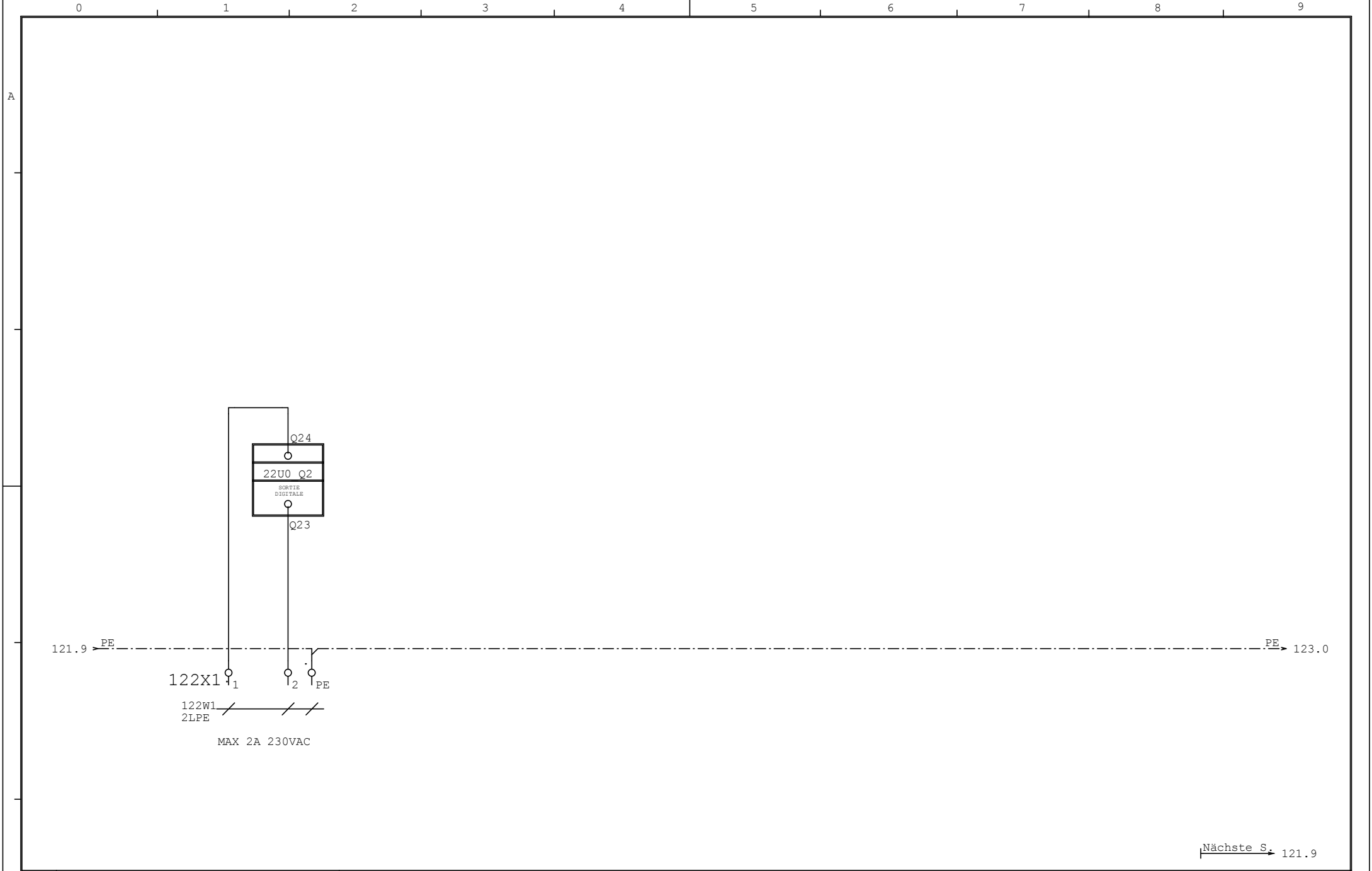

Nächste S. 121.9

			Datum	03.07.2014	SCHAKO (SUISSE) SA 1762 Givisiez		DIGITALEINGANG 2 (RESERVE)	NETZWERK. ZEHNDER 1 MAS. 1 MON.	=		
			Verant.							+	
			Kontr.								
Vers.	Modifikat.	Datum	Name	Norme	Original	Ersetzt:	Ersetzt von:		200008_s04k	Folio 122 von 126S.	



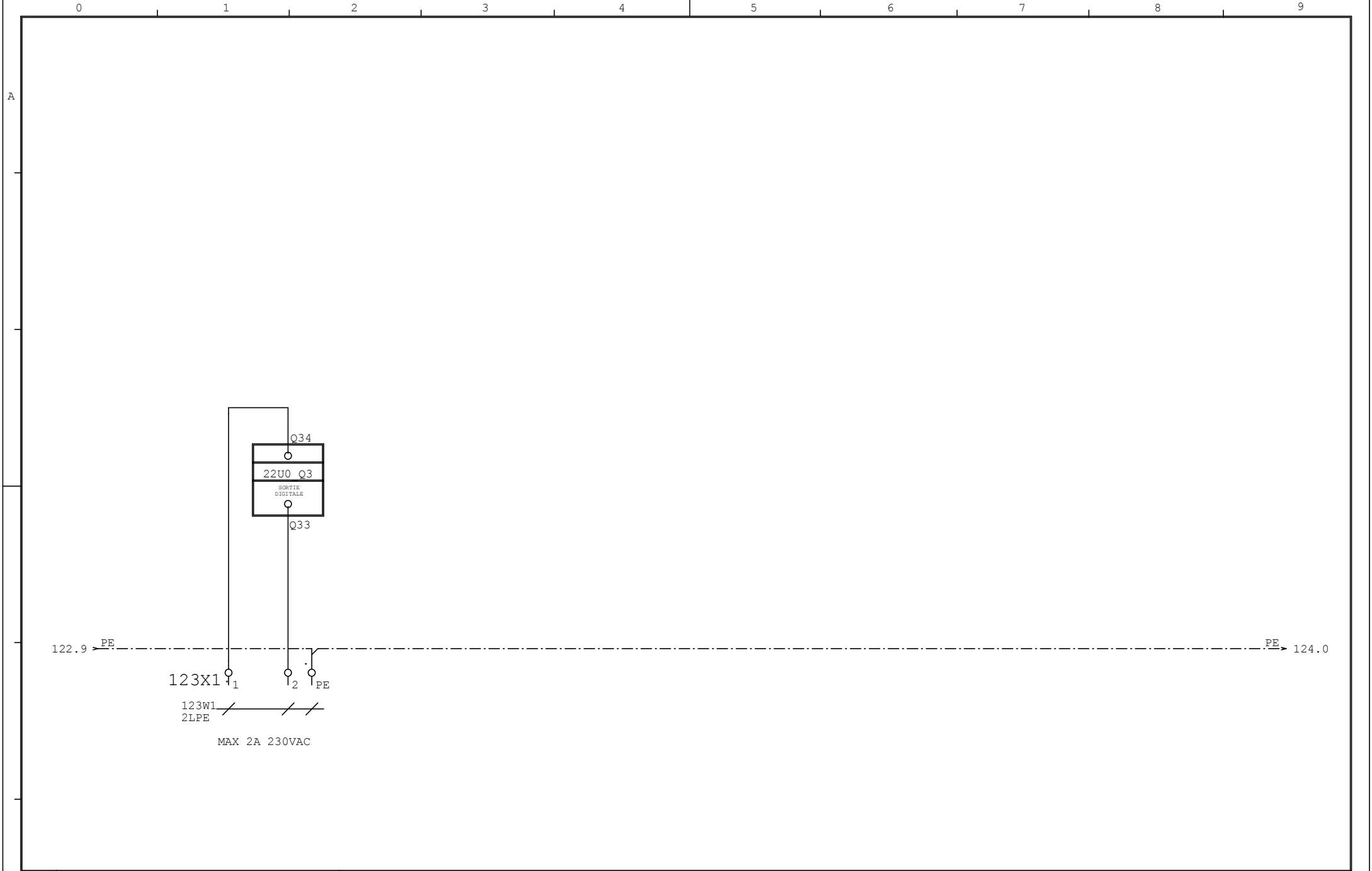

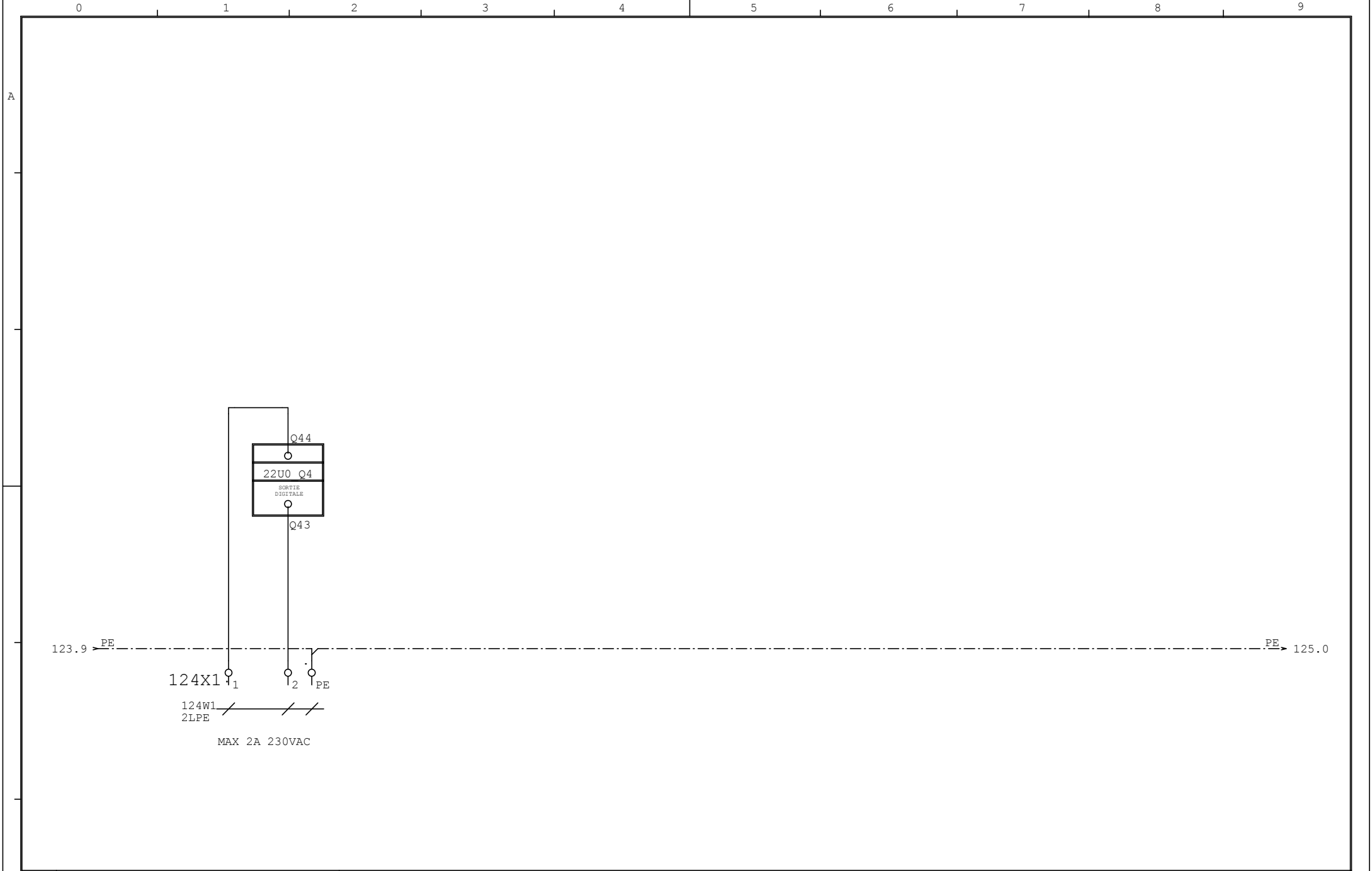

			Datum	03.07.2014	SCHAKO (SUISSE) SA			DIGITALEINGANG 3 (RESERVE)		NETZWERK. ZEHNDER 1 MAS. 1 MON.		=	
			Verant.		1762 Givisiez								+
			Kontr.										
Vers.	Modifikat.	Datum	Name	Norme	Original	Ersetzt:	Ersetzt von:			200008_s04k		Folio 123 von 126S.	

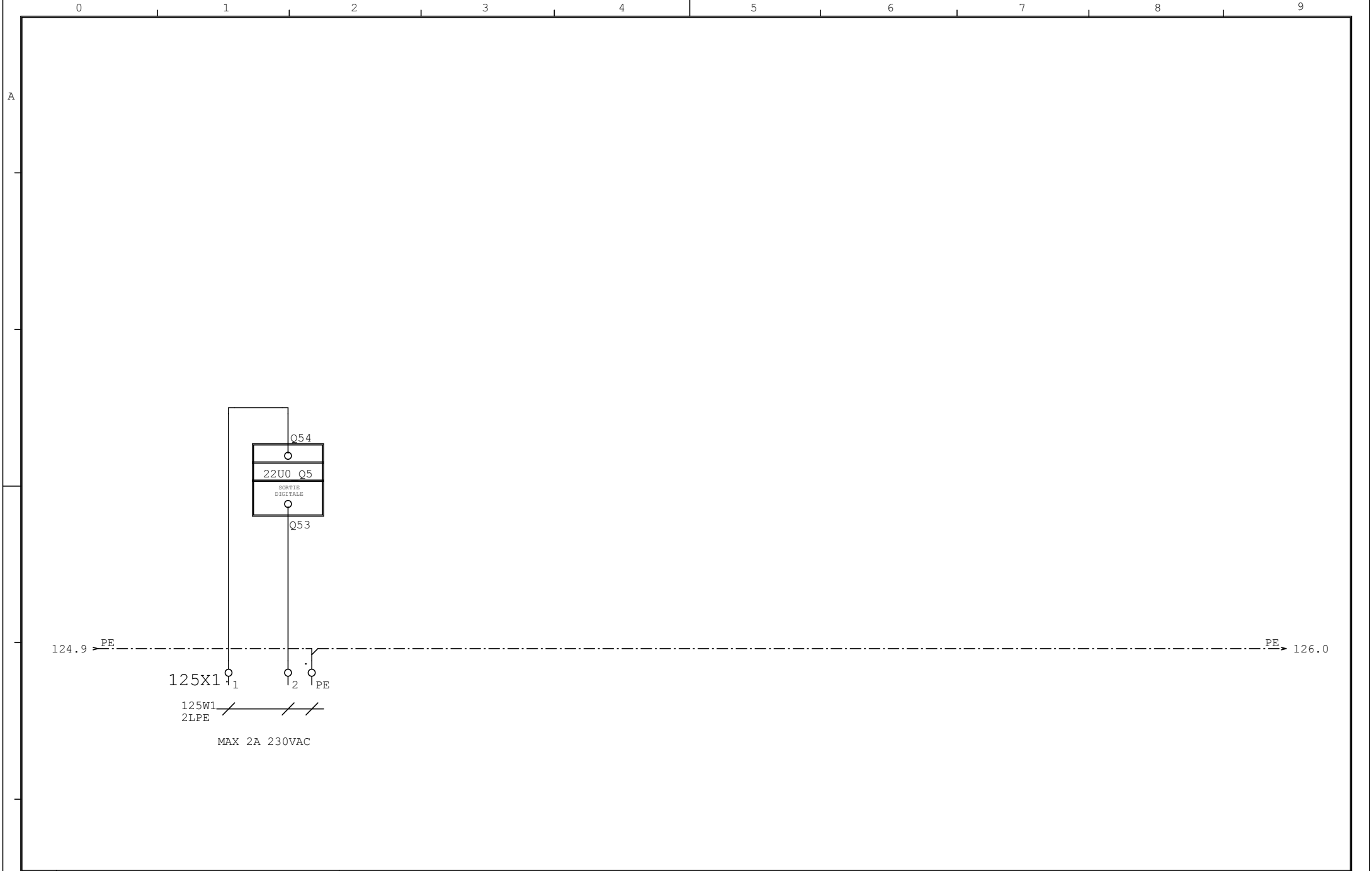

			Datum	03.07.2014	SCHAKO (SUISSE) SA			DIGITALEINGANG 4 (RESERVE)	NETZWERK. ZEHNDER 1 MAS. 1 MON.	=	
			Verant.		1762 Givisiez					+	
			Kontr.								
Vers.	Modifikat.	Datum	Name	Norme	Original	Ersetzt:	Ersetzt von:		200008_s04k	Folio 124	von 126S.



			Datum	03.07.2014	SCHAKO (SUISSE) SA 1762 Givisiez		DIGITALEINGANG 5 (RESERVE)	NETZWERK. ZEHNDER 1 MAS. 1 MON.	=				
			Verant.									+	
			Kontr.										
Vers.	Modifikat.	Datum	Name	Norme	Original	Ersetzt:	Ersetzt von:		200008_s04k	Folio 125 von 126S.			

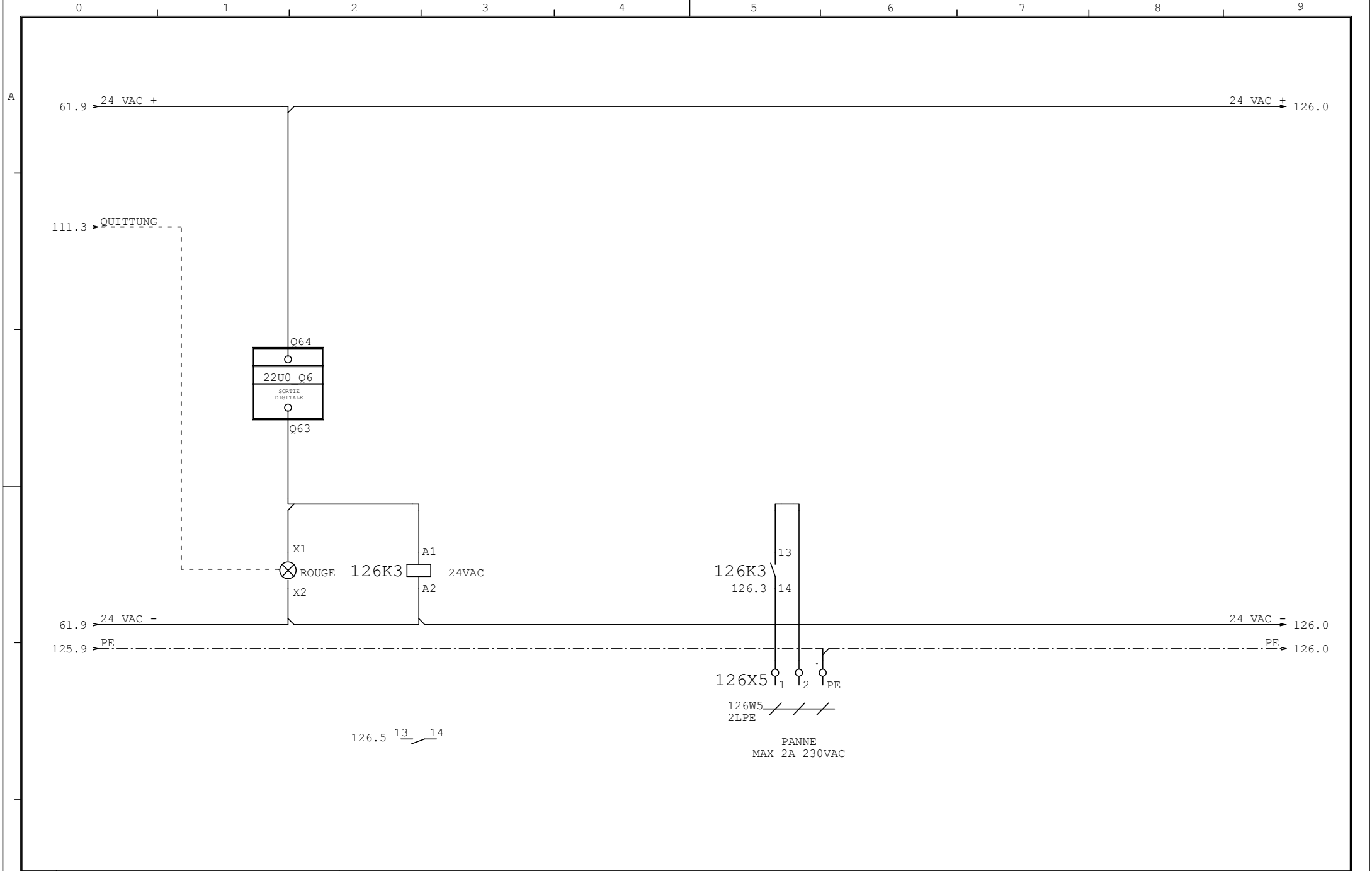

			Datum	03.07.2014	SCHAKO (SUISSE) SA			PANNE	NETZWERK. ZEHNDER 1 MAS. 1 MON.		=
			Verant.		1762 Givisiez						+
			Kontr.		Original			Ersetzt von:	200008_S04k		Folio 126
Vers.	Modifikat.	Datum	Name	Norme	Original	Ersetzt:	Ersetzt von:			von 126S.	